



The Garador Range Price List

1st June 2023

Garage Doors, Front Entrance Doors and Automatic Operators



General Information

All prices are quoted in £ Sterling, ex-works and exclusive of VAT.

Our doors are for residential purposes only and not for commercial use.

Please ensure that you order the correct size door to fit your opening as we are unable to accept the return of incorrectly ordered goods. Please contact Garador on 01935 443722 if you need assistance in calculating the correct size. A comprehensive range of the less common accessories and all spare parts are available either online or ask for a current spares price list if required.

Since the company's policy is one of continuous improvement of its products, we reserve the right to make any alterations in design, manufacture or price.

All business is governed by the Company's Standard Conditions and this document does not form any part of any contract with the company and statements contained in it should not be construed as representations or warranties.

For more information please visit
www.garador.co.uk



Contents

Frame Dimensions for Panel Doors	4
Steel Panel Doors	6
Guardian Range	16
Design Range	18
GRP Premier Panel Doors	20
Timber Panel Doors	26
Steel and Timber Garage Side Doors	36
Steel, Timber and GRP Side-hinged Doors	38
Garage Side Doors & Side-hinged Doors – Specifications	45
Steel Panel Doors – Specifications	46
Steel Sectional Garage Doors	48
Automation and Accessories	72
GaraRoll Roller Doors	78
GaraGlide Roller Doors	82
User Information / Care	86
Warranty	88
Extracts from DHF consumer advice	90

Frame Dimensions for Panel Doors

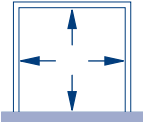
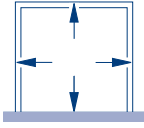
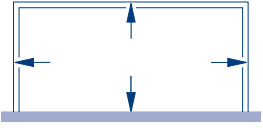
Size Code				
	Internal frame size On-site timber frame Width x Height (mm x mm)	Pre-framed canopy door overall frame sizes shown ¹ Width x Height (mm x mm)	Pre-framed retractable door overall frame sizes shown ¹ Width x Height (mm x mm)	Frame kit for double door overall frame sizes shown ¹ Width x Height (mm x mm)
6660	1984 x 1830	2094 x 1888	2124 x 1888	-
6663	1984 x 1905	2094 x 1963	2124 x 1963	-
6664	1984 x 1931	2094 x 1989	2124 x 1989	-
6666	1984 x 1981	2094 x 2039	2124 x 2039	-
6670	1984 x 2136	2094 x 2194	2124 x 2194	-
61064	2084 x 1931	2194 x 1989	2224 x 1989	-
61066	2084 x 1981	2194 x 2039	2224 x 2039	-
61070	2084 x 2136	2194 x 2194	2224 x 2194	-
7060	2134 x 1830	2244 x 1888	2274 x 1888	-
7063	2134 x 1905	2244 x 1963	2274 x 1963	-
7064	2134 x 1931	2244 x 1989	2274 x 1989	-
7066	2134 x 1981	2244 x 2039	2274 x 2039	-
7068	2134 x 2036	2244 x 2094	2274 x 2094	-
7070	2134 x 2136	2244 x 2194	2274 x 2194	-
7072	2134 x 2186	-	2274 x 2244	-
7076	2134 x 2286	-	2274 x 2344	-
7163	2170 x 1905	2280 x 1963	2310 x 1963	-
7164	2170 x 1931	2280 x 1989	2310 x 1989	-
7166	2170 x 1981	2280 x 2039	2310 x 2039	-
7168	2170 x 2036	2280 x 2094	2310 x 2094	-
7170	2170 x 2136	2280 x 2194	2310 x 2194	-
7172	2170 x 2186	-	2310 x 2244	-
7176	2170 x 2286	-	2310 x 2344	-
7364	2224 x 1931	2334 x 1989	2364 x 1989	-
7366	2224 x 1981	2334 x 2039	2364 x 2039	-
7370	2224 x 2136	2334 x 2194	2364 x 2194	-
7563	2259 x 1905	2369 x 1963	2399 x 1963	-
7564	2259 x 1931	2369 x 1989	2399 x 1989	-
7566	2259 x 1981	2369 x 2039	2399 x 2039	-
7568	2259 x 2036	2369 x 2094	2399 x 2094	-
7570	2259 x 2136	2369 x 2194	2399 x 2194	-
7572	2259 x 2186	-	2399 x 2244	-
7576	2259 x 2286	-	2399 x 2344	-
7663	2284 x 1905	2394 x 1963	2424 x 1963	-
7664	2284 x 1931	2394 x 1989	2424 x 1989	-
7666	2284 x 1981	2394 x 2039	2424 x 2039	-
7668	2284 x 2036	2394 x 2094	2424 x 2094	-
7670	2284 x 2136	2394 x 2194	2424 x 2194	-
7672	2284 x 2186	-	2424 x 2244	-
7676	2284 x 2286	-	2424 x 2344	-
8063	2439 x 1905	2549 x 1963	2579 x 1963	-
8064	2439 x 1931	2549 x 1989	2579 x 1989	-
8066	2439 x 1981	2549 x 2039	2579 x 2039	-
8068	2439 x 2036	2549 x 2094	2579 x 2094	-
8070	2439 x 2136	2549 x 2194	2579 x 2194	-
8072	2439 x 2186	-	2579 x 2244	-

¹ No fitting clearance allowed. If door is fitted between the brickwork a minimum of 10 mm clearance over the width and 5 mm over the height should be added to the overall frame size when selecting the door.

GARADOR Frame Dimensions for Panel Doors

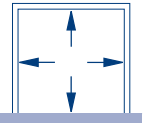
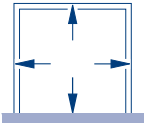
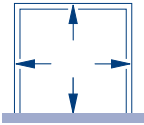
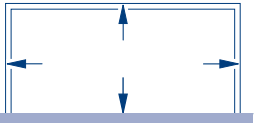
Size Code	 Internal frame size On-site timber frame Width x Height (mm x mm)	 Pre-framed canopy door overall frame sizes shown ¹ Width x Height (mm x mm)	 Pre-framed retractable door overall frame sizes shown ¹ Width x Height (mm x mm)	 Frame kit for double door overall frame sizes shown ¹ Width x Height (mm x mm)
8076	2439 x 2286	–	2579 x 2344	–
8666	2590 x 1981	–	2730 x 2039	–
8670	2590 x 2136	–	2730 x 2194	–
8676	2590 x 2286	–	2730 x 2344	–
9066	2744 x 1981	–	2884 x 2039	–
9070	2744 x 2136	–	2884 x 2194	–
9076	2744 x 2286	–	2884 x 2344	–
1066	3049 x 1981	–	3189 x 2039	–
1070	3049 x 2136	–	3189 x 2194	–
1076	3049 x 2286	–	–	3189 x 2344
1166	3354 x 1981	–	–	3494 x 2039
1170	3354 x 2136	–	–	3494 x 2194
1176	3354 x 2286	–	–	3494 x 2344
1266	3659 x 1981	–	–	3799 x 2039
1270	3659 x 2136	–	–	3799 x 2194
1276	3659 x 2286	–	–	3799 x 2344
1366	3964 x 1981	–	–	4104 x 2039
1370	3964 x 2136	–	–	4104 x 2194
1376	3964 x 2286	–	–	4104 x 2344
1466	4269 x 1981	–	–	4409 x 2039
1470	4269 x 2136	–	–	4409 x 2194
1566	4574 x 1981	–	–	4714 x 2039
1570	4574 x 2136	–	–	4714 x 2194
1666	4879 x 1981	–	–	5019 x 2039
1670	4879 x 2136	–	–	5019 x 2194

¹ No fitting clearance allowed. If door is fitted between the brickwork a minimum of 10 mm clearance over the width and 5 mm over the height should be added to the overall frame size when selecting the door.

Steel Panel Doors

Surface

High quality powder or foil coated finish.

Please note: panel doors are produced with appearance in mind. This may result in some small gaps which could allow water ingress especially in exposed locations.

Colours

All doors supplied in Traffic White (RAL 9016) as standard.

Optional colours available:

- | | | | |
|--------------------------|--------------------------|------------------------------|-----------------------------|
| - Light Ivory (RAL 1015) | - Pigeon Blue (RAL 5014) | - Anthracite Grey (RAL 7016) | - Burgundy Brown |
| - Ruby Red (RAL 3003) | - Moss Green (RAL 6005) | - Terra Brown (RAL 8028) | - Golden Brown |
| - Signal Blue (RAL 5005) | - Fir Green (RAL 6009) | - Jet Black (RAL 9005) | - Chartwell Green (BS 4800) |
| - Steel Blue (RAL 5011) | - Slate Grey (RAL 7015) | - Window Grey (RAL 7040) | - Agate Grey (RAL 7038) |
| - Stone Grey (RAL 7030) | - Light grey (RAL 7035) | | |

Timber effect finishes are available in either a Golden Oak or Rosewood foil coat timber effect.

Handle

Black handle as standard, optional handles are available. Doors can be supplied undrilled and without handle and locking mechanism for use with electric operator (not available on Wentwood or Sherwood doors). This option makes the door purpose made and will therefore increase lead-time, please specify clearly on order.

Terminology

Nominal Door Size: This is the actual door panel size plus the fitting tolerances. The nominal door size should be used for internal dimensions of a timber frame.

Size Code: This has traditionally been used to order doors. This may not be the actual door size.

Stock availability

Prices in bold show stock doors in Traffic White (unless specified) and all other prices relate to non-stock doors.

Packaging

All doors are supplied unwrapped as standard, with optional poly-wrapping available.

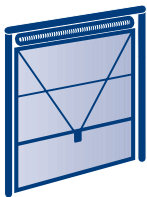

Canopy gearing (shown as C)

Canopy gear is available for all single doors providing a reliable and affordable gearing solution, with no tracks running back into the garage.

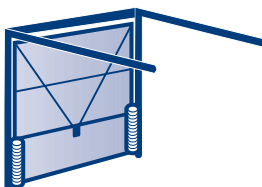

Retractable gearing (shown as R)

Retractable gear is available for all single and double doors providing a reliable and affordable gearing solution, with tracks running back into the garage.

Single door

Nominal Door Size
Width x Height
(mm x mm)

Size
Code

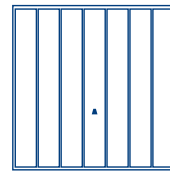
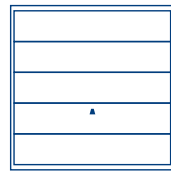
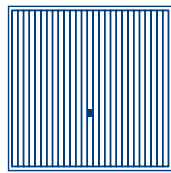
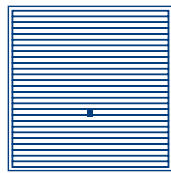

Horizon

Carlton

Ascot

Windsor

	Size Code	Horizon		Carlton		Ascot		Windsor	
		C	R	C	R	C	R	C	R
1984 x 1830	6660	831	880	942	991	-	-	-	-
1984 x 1905	6663	831	880	942	991	-	-	-	-
1984 x 1931	6664	831	880	942	991	-	-	-	-
1984 x 1981	6666	787	836	895	944	-	-	-	-
1984 x 2136	6670	787	836	895	944	-	-	-	-
2084 x 1931	61064	802	851	894	943	-	-	-	-
2084 x 1981	61066	825	874	894	943	-	-	-	-
2084 x 2136	61070	854	903	914	963	-	-	-	-
2134 x 1830	7060	855	904	967	1016	-	-	-	-
2134 x 1905	7063	855	904	967	1016	-	-	-	-
2134 x 1931	7064	813	862	900	949	-	-	-	-
2134 x 1981	7066	753 ¹	802 ¹	870 ¹	919 ¹	917 ¹	966 ¹	1072	1121
2134 x 2036	7068	859	908	951	1000	-	-	-	-
2134 x 2136	7070	826 ¹	875 ¹	907 ¹	956 ¹	1024 ¹	1073 ¹	1106	1155
2134 x 2186	7072	-	937	-	1020	-	-	-	-
2134 x 2286	7076	-	1049	-	1125	-	-	-	-
2170 x 1905	7163	813	862	900	949	-	-	-	-
2170 x 1931	7164	813	862	900	949	-	-	-	-
2170 x 1981	7166	753	802	870	919	917	966	1072	1121
2170 x 2036	7168	859	908	951	1000	-	-	-	-
2170 x 2136	7170	826	875	907	956	1024	1073	1106	1155
2170 x 2186	7172	-	937	-	1020	-	-	-	-
2170 x 2286	7176	-	1160	-	1222	-	-	-	-
2224 x 1905	7363	885	934	941	990	-	-	-	-
2224 x 1931	7364	885	934	941	990	-	-	-	-
2224 x 1981	7366	888	937	945	994	-	-	-	-
2224 x 2136	7370	901	950	957	1006	-	-	-	-
2259 x 1905	7563	877	926	951	1000	-	-	-	-
2259 x 1931	7564	877	926	951	1000	-	-	-	-
2259 x 1981	7566	885	934	951	1000	1050	1099	1146	1195
2259 x 2036	7568	925	974	1003	1052	-	-	-	-
2259 x 2136	7570	1005	1054	1071	1120	1192	1241	1239	1288
2259 x 2186	7572	-	1128	-	1154	-	-	-	-
2259 x 2286	7576	-	1250	-	1222	-	-	-	-
2284 x 1905	7663	885	934	976	1025	-	-	-	-
2284 x 1931	7664	885	934	976	1025	-	-	-	-
2284 x 1981	7666	885	934	976	1025	1050	1099	1146	1195
2284 x 2036	7668	936	985	1031	1080	-	-	-	-
2284 x 2136	7670	1009	1058	1071 ¹	1120 ¹	1177	1226	1239	1288
2284 x 2186	7672	-	1130	-	1195	-	-	-	-
2284 x 2286	7676	-	1254	-	1222	-	-	-	-
2439 x 1905	8063	1020	1069	1156	1205	-	-	-	-
2439 x 1931	8064	1020	1069	1156	1205	-	-	-	-
2439 x 1981	8066	1020	1069	1156	1205	1169	1218	1330	1379
2439 x 2036	8068	1077	1126	1219	1268	-	-	-	-
2439 x 2136	8070	1043	1092	1194 ¹	1243 ¹	1207 ¹	1256 ¹	1368	1417
2439 x 2186	8072	-	1164	-	1327	-	-	-	-
2439 x 2286	8076	-	1223	-	1331	-	-	-	-
2590 x 1981	8666	-	1177	-	1327	-	-	-	-
2590 x 2136	8670	-	1219	-	1381	-	-	-	-
2590 x 2286	8676	-	1344	-	1501	-	-	-	-
2744 x 1981	9066	-	1407	-	1424	-	-	-	-
2744 x 2136	9070	-	1478	-	1501	-	-	-	-
2744 x 2286	9076	-	1535	-	1557	-	-	-	-
3049 x 1981	1066	-	1659	-	1600	-	-	-	-
3049 x 2136	1070	-	1679	-	1618	-	-	-	-

Stock doors also available in Jet Black (based on RAL 9005).

¹ Stock doors also available in Anthracite Grey (RAL 7016)

For further options please see page 15.

Single door

Nominal Door Size
Width x Height
(mm x mm)

Size
Code

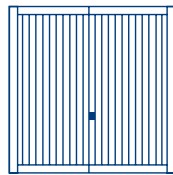

Sutton

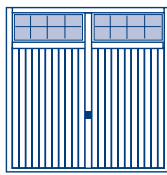

Salisbury ¹

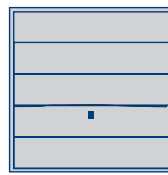

Wentwood
Timber Effect

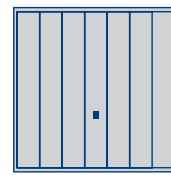

Sherwood
Timber Effect

Nominal Door Size Width x Height (mm x mm)	Size Code	Sutton		Salisbury ¹		Wentwood Timber Effect		Sherwood Timber Effect	
		C	R	C	R	C	R	C	R
1984 x 1830	6660	-	-	-	-	-	-	-	-
1984 x 1905	6663	-	-	-	-	-	-	-	-
1984 x 1931	6664	-	-	-	-	-	-	-	-
1984 x 1981	6666	-	-	-	-	-	-	-	-
1984 x 2136	6670	-	-	-	-	-	-	-	-
2084 x 1931	61064	-	-	-	-	-	-	-	-
2084 x 1981	61066	-	-	-	-	-	-	-	-
2084 x 2136	61070	-	-	-	-	-	-	-	-
2134 x 1830	7060	-	-	-	-	-	-	-	-
2134 x 1905	7063	-	-	-	-	-	-	-	-
2134 x 1931	7064	983	1032	1495	1544	-	-	-	-
2134 x 1981	7066	931	980	1495	1544	968	1017	1123	1172
2134 x 2036	7068	-	-	1576	1625	-	-	-	-
2134 x 2136	7070	992	1041	1512	1561	1075	1124	1156	1205
2134 x 2186	7072	-	-	-	1646	-	-	-	-
2134 x 2286	7076	-	-	-	-	-	-	-	-
2170 x 1931	7164	-	-	-	-	-	-	-	-
2170 x 1981	7166	-	-	-	-	-	-	-	-
2170 x 2036	7168	-	-	-	-	-	-	-	-
2170 x 2136	7170	-	-	-	-	-	-	-	-
2170 x 2186	7172	-	-	-	-	-	-	-	-
2170 x 2286	7176	-	-	-	-	-	-	-	-
2224 x 1931	7364	-	-	-	-	-	-	-	-
2224 x 1981	7366	-	-	-	-	-	-	-	-
2224 x 2136	7370	-	-	-	-	-	-	-	-
2259 x 1931	7564	1078	1127	1555	1604	-	-	-	-
2259 x 1981	7566	1078	1127	1555	1604	-	-	-	-
2259 x 2036	7568	-	-	1636	1685	-	-	-	-
2259 x 2136	7570	1187	1236	1570	1619	-	-	-	-
2259 x 2186	7572	-	-	-	1704	-	-	-	-
2259 x 2286	7576	-	-	-	-	-	-	-	-
2284 x 1931	7664	1090	1139	1555	1604	-	-	-	-
2284 x 1981	7666	1035	1084	1555	1604	1101	1150	1195	1244
2284 x 2036	7668	-	-	1636	1685	-	-	-	-
2284 x 2136	7670	1143	1192	1570 ²	1619 ²	1225	1274	1291	1340
2284 x 2186	7672	-	-	-	1704	-	-	-	-
2284 x 2286	7676	-	-	-	-	-	-	-	-
2439 x 1931	8064	1201	1250	1651	1700	-	-	-	-
2439 x 1981	8066	1201	1250	1651	1700	1218	1267	1377	1426
2439 x 2036	8068	-	-	1732	1781	-	-	-	-
2439 x 2136	8070	1222	1271	1665	1714	1261	1310	1421	1470
2439 x 2186	8072	-	-	-	1799	-	-	-	-
2439 x 2286	8076	-	-	-	-	-	-	-	-
2590 x 1981	8666	-	-	-	-	-	-	-	-
2590 x 2136	8670	-	-	-	-	-	-	-	-
2590 x 2286	8676	-	-	-	-	-	-	-	-
2744 x 1981	9066	-	-	-	-	-	-	-	-
2744 x 2136	9070	-	-	-	-	-	-	-	-
2744 x 2286	9076	-	-	-	-	-	-	-	-
3049 x 1981	1066	-	-	-	-	-	-	-	-
3049 x 2136	1070	-	-	-	-	-	-	-	-

¹ Salisbury windows (with window icon) come as white as standard, colour match windows are available to order as an option, see page 15.

² Also available on 1 week lead time in Jet Black (RAL 9005) with black colour match windows.

Please note that doors with windows may have cross bracing or locking rods passing behind the windows depending upon size and gear type.

Stock doors also available in Jet Black (based on RAL 9005).

Wentwood and Sherwood models are only available in either a Golden Oak or Rosewood foil coat timber effect finish.

For further options please see page 15.

Single door

Nominal Door Size
Width x Height
(mm x mm)

Size
Code

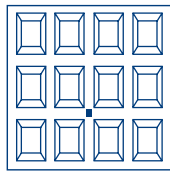

Georgian

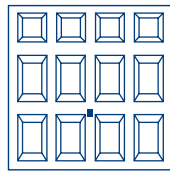

Beaumont

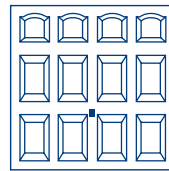

Cathedral

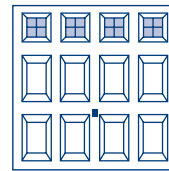

Beaumont with
Windows¹

Nominal Door Size Width x Height (mm x mm)	Size Code	Georgian		Beaumont		Cathedral		Beaumont with Windows ¹	
		C	R	C	R	C	R	C	R
1984 x 1830	6660	-	-	-	-	-	-	-	-
1984 x 1905	6663	-	-	-	-	-	-	-	-
1984 x 1931	6664	1152	1201	1152	1201	1152	1201	1568	1617
1984 x 1981	6666	1091	1140	1091	1140	1091	1140	1574	1623
1984 x 2136	6670	1107	1156	1107	1156	1107	1156	1523	1572
2084 x 1931	61064	1103	1152	1103	1152	1103	1152	1519	1568
2084 x 1981	61066	1105	1154	1105	1154	1105	1154	1521	1570
2084 x 2136	61070	1186	1235	1186	1235	1186	1235	1599	1648
2134 x 1830	7060	-	-	-	-	-	-	-	-
2134 x 1905	7063	-	-	-	-	-	-	-	-
2134 x 1931	7064	1105	1154	1105	1154	1105	1154	1521	1570
2134 x 1981	7066	1105	1154	1105	1154	1105	1154	1521	1570
2134 x 2136	7070	1171	1220	1171	1220	1171	1220	1584	1633
2134 x 2286	7076	-	1393	-	1393	-	1393	-	1806
2170 x 1931	7164	1105	1154	1105	1154	1105	1154	1521	1570
2170 x 1981	7166	1105	1154	1105	1154	1105	1154	1521	1570
2170 x 2136	7170	1171	1220	1171	1220	1171	1220	1584	1633
2170 x 2286	7176	-	1506	-	1506	-	1506	-	1921
2224 x 1931	7364	1228	1277	1228	1277	1228	1277	1646	1695
2224 x 1981	7366	1235	1284	1235	1284	1235	1284	1652	1701
2224 x 2136	7370	1242	1291	1242	1291	1242	1291	1659	1708
2259 x 1931	7564	1228	1277	1228	1277	1228	1277	1646	1695
2259 x 1981	7566	1228	1277	1228	1277	1228	1277	1646	1695
2259 x 2136	7570	1413	1462	1413	1462	1413	1462	1833	1882
2259 x 2286	7576	-	1716	-	1716	-	1716	-	2131
2284 x 1931	7664	1228	1277	1228	1277	1228	1277	1646	1695
2284 x 1981	7666	1228	1277	1228	1277	1228	1277	1646	1695
2284 x 2136	7670	1413	1462	1413	1462	1413	1462	1833	1882
2284 x 2286	7676	-	1716	-	1716	-	1716	-	2131
2439 x 1931	8064	1454	1503	1454	1503	1454	1503	1870	1919
2439 x 1981	8066	1454	1503	1454	1503	1454	1503	1870	1919
2439 x 2136	8070	1515	1564	1515	1564	1515	1564	1930	1979
2439 x 2286	8076	-	1683	-	1683	-	1683	-	2166
2590 x 1981	8666	-	1551	-	1551	-	1551	-	2031
2590 x 2136	8670	-	1569	-	1569	-	1569	-	2051
2590 x 2286	8676	-	1738	-	1738	-	1738	-	2217
2744 x 1981	9066	-	1574	-	1574	-	1574	-	2058
2744 x 2136	9070	-	1595	-	1595	-	1595	-	2075
2744 x 2286	9076	-	1762	-	1762	-	1762	-	2245
3049 x 1981	1066	-	1633	-	1633	-	1633	-	2118
3049 x 2136	1070	-	1667	-	1667	-	1667	-	2153

¹ Windows for Beaumont: Standard (□), Diamond (◊), Cross (⊕). Please state on order if clear or crystal panes, see page 15.

Please note that doors with windows may have cross bracing or locking rods passing behind the windows depending upon size and gear type.

Stock doors also available in Jet Black (based on RAL 9005).

For further options please see page 15.

Single door

Nominal Door Size
Width x Height
(mm x mm)

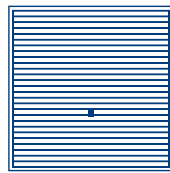

Horizon

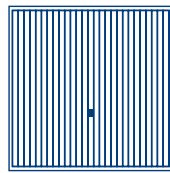

Carlton

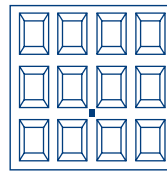

Georgian

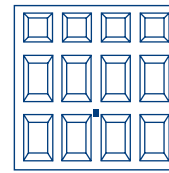

Beaumont

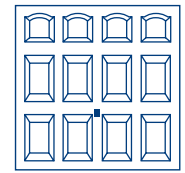

Cathedral

		Horizon		Carlton		Georgian		Beaumont		Cathedral	
		C	R	C	R	C	R	C	R	C	R
1830-1930	x 1830-1930	1097	1146	1138	1187	-	-	-	-	-	-
1830-1930	x 1931-1981	1137	1186	1180	1229	-	-	-	-	-	-
1830-1930	x 1982-2136	1223	1272	1249	1298	-	-	-	-	-	-
1830-1930	x 2137-2286	-	1376	-	1423	-	-	-	-	-	-
1830-1930	x 2287-2439	-	-	-	1515	-	-	-	-	-	-
1931-1984	x 1830-1930	1103	1152	1152	1201	-	-	-	-	-	-
1931-1984	x 1931-1981	1145	1194	1190	1239	-	-	-	-	-	-
1931-1984	x 1982-2136	1215	1264	1254	1303	-	-	-	-	-	-
1931-1984	x 2137-2286	-	1376	-	1423	-	-	-	-	-	-
1931-1984	x 2287-2439	-	1476	-	1515	-	-	-	-	-	-
1985-2134	x 1830-1930	1145	1194	1188	1237	-	-	-	-	-	-
1985-2134	x 1931-1981	1215	1264	1254	1303	1727	1776	1727	1776	1727	1776
1985-2134	x 1982-2136	1311	1360	1336	1385	1834	1883	1834	1883	1834	1883
1985-2134	x 2137-2286	-	1476	-	1515	-	2015	-	2015	-	2015
1985-2134	x 2287-2439	-	1569	-	1597	-	1943	-	1943	-	1943
2135-2284	x 1830-1930	1215	1264	1238	1287	-	-	-	-	-	-
2135-2284	x 1931-1981	1311	1360	1336	1385	1849	1898	1849	1898	1849	1898
2135-2284	x 1982-2136	1393	1442	1438	1487	1849	1898	1849	1898	1849	1898
2135-2284	x 2137-2286	-	1569	-	1597	-	1996	-	1996	-	1996
2135-2284	x 2287-2439	-	1666	-	1708	-	2272	-	2272	-	2272
2285-2499 ¹	x 1830-1930	1311	1360	1350	1399	-	-	-	-	-	-
2285-2499 ¹	x 1931-1981	1393	1442	1438	1487	1962	2011	1962	2011	1962	2011
2285-2499 ¹	x 1982-2136	1404	1453	1515	1564	1995	2044	1995	2044	1995	2044
2285-2499	x 2137-2286	-	1600	-	1633	-	2123	-	2123	-	2123
2285-2499	x 2287-2439	-	1667	-	1684	-	2209	-	2209	-	2209
2500-2590	x 1830-1930	-	1501	-	1527	-	-	-	-	-	-
2500-2590	x 1931-1981	-	1569	-	1597	-	2105	-	2105	-	2105
2500-2590	x 1982-2136	-	1667	-	1667	-	2138	-	2138	-	2138
2500-2590	x 2137-2286	-	1684	-	1684	-	2187	-	2187	-	2187
2500-2590	x 2287-2439	-	1787	-	1787	-	2259	-	2259	-	2259
2591-2722	x 1830-1930	-	1595	-	1595	-	-	-	-	-	-
2591-2722	x 1931-1981	-	1659	-	1659	-	2114	-	2114	-	2114
2591-2722	x 1982-2136	-	1774	-	1774	-	2214	-	2214	-	2214
2591-2722	x 2137-2286	-	1885	-	1885	-	2281	-	2281	-	2281
2591-2722	x 2287-2439	-	2010	-	2010	-	-	-	-	-	-
2723-3049	x 1830-1930	-	-	-	1941	-	-	-	-	-	-
2723-3049	x 1931-1981	-	-	-	2009	-	2259	-	2259	-	2259
2723-3049	x 1982-2136	-	-	-	2213	-	2343	-	2343	-	2343

¹ Canopy gear only available up to 2439 wide.

Orders for purpose made sizes will only be accepted as nominal door size for unframed version and overall frame size when ordering a framed version. Orders for purpose made framed doors will not be accepted as nominal door size.

For further options please see page 15.

Single door

Nominal Door Size
Width x Height
(mm x mm)

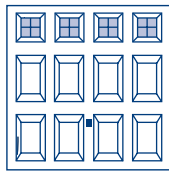

Beaumont with
Windows²

C R

1830-1930	x	1830-1930	-	-
1830-1930	x	1931-1981	-	-
1830-1930	x	1982-2136	-	-
1830-1930	x	2137-2286	-	-
1830-1930	x	2287-2439	-	-
1931-1984	x	1830-1930	-	-
1931-1984	x	1931-1981	-	-
1931-1984	x	1982-2136	-	-
1931-1984	x	2137-2286	-	-
1931-1984	x	2287-2439	-	-
1985-2134	x	1830-1930	-	-
1985-2134	x	1931-1981	2141	2190
1985-2134	x	1982-2136	2250	2299
1985-2134	x	2137-2286	-	2430
1985-2134	x	2287-2439	-	2358
2135-2284	x	1830-1930	-	-
2135-2284	x	1931-1981	2267	2316
2135-2284	x	1982-2136	2267	2316
2135-2284	x	2137-2286	-	2414
2135-2284	x	2287-2439	-	2688
2285-2499 ¹	x	1830-1930	-	-
2285-2499 ¹	x	1931-1981	2381	2430
2285-2499 ¹	x	1982-2136	2413	2462
2285-2499	x	2137-2286	-	2540
2285-2499	x	2287-2439	-	2625
2500-2590	x	1830-1930	-	-
2500-2590	x	1931-1981	-	2522
2500-2590	x	1982-2136	-	2557
2500-2590	x	2137-2286	-	2605
2500-2590	x	2287-2439	-	2672
2591-2722	x	1830-1930	-	-
2591-2722	x	1931-1981	-	2530
2591-2722	x	1982-2136	-	2634
2591-2722	x	2137-2286	-	2699
2591-2722	x	2287-2439	-	-
2723-3049	x	1830-1930	-	-
2723-3049	x	1931-1981	-	2672
2723-3049	x	1982-2136	-	2759

¹ Canopy gear only available up to 2439 wide.

² Windows for Beaumont: Standard , Diamond , Cross . Please state on order if clear or crystal panes.

Orders for purpose made sizes will only be accepted as nominal door size for unframed version and overall frame size when ordering a framed version. Orders for purpose made framed doors will not be accepted as nominal door size.

Please note that doors with windows may have cross bracing or locking rods passing behind the windows depending upon size and gear type.

For further options please see page 15.

Double door

Nominal Door Size
Width x Height
(mm x mm)

Size
Code

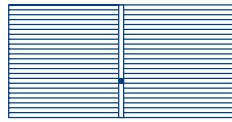

Horizon

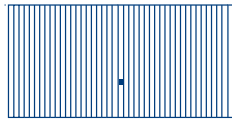

Carlton

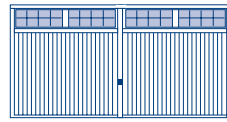

Salisbury

		R	R	R
3049 x 2286	1076	2148	2148	-
3354 x 1981	1166	2009	2009	-
3354 x 2136	1170	2024	2024	-
3354 x 2286	1176	2076	2076	-
3659 x 1981	1266	2109	2109	-
3659 x 2136	1270	2125	2125	-
3659 x 2286	1276	2275	2275	-
3964 x 1981	1366	2295	2295	-
3964 x 2136	1370	2312	2312	-
3964 x 2286	1376	2533	2533	-
4269 x 1981	1466	2211	2211	3061
4269 x 2136	1470	2211	2211	3061
4574 x 1981	1566	2381	2381	-
4574 x 2136	1570	2416	2416	-
4879 x 1981	1666	2518	2518	-
4879 x 2136	1670	2550	2550	-

Double door

Nominal Door Size
Width x Height
(mm x mm)

Size
Code

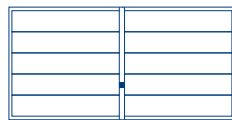

Ascot

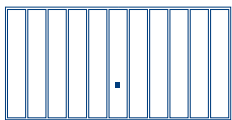

Windsor

		R	R
3049 x 2286	1076	-	-
3354 x 1981	1166	-	-
3354 x 2136	1170	-	-
3354 x 2286	1176	-	-
3659 x 1981	1266	-	-
3659 x 2136	1270	-	-
3659 x 2286	1276	-	-
3964 x 1981	1366	-	-
3964 x 2136	1370	-	-
3964 x 2286	1376	-	-
4269 x 1981	1466	2338	2338
4269 x 2136	1470	2338	2338
4574 x 1981	1566	-	-
4574 x 2136	1570	-	-
4879 x 1981	1666	-	-
4879 x 2136	1670	-	-

Please note that doors with windows may have cross bracing or locking rods passing behind the windows depending upon size and gear type.

For further options please see page 15.

Double door

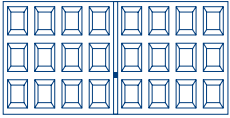
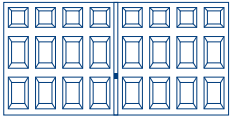
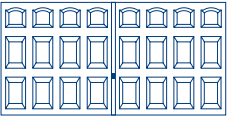
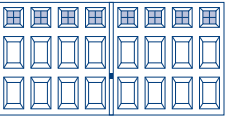
Nominal Door Size Width x Height (mm x mm)	Size Code				
		Georgian	Beaumont	Cathedral	Beaumont with Windows ¹
		R	R	R	R
3049 x 2286	1076	2148	2148	2148	2767
3354 x 1981	1166	2109	2109	2109	2736
3354 x 2136	1170	2109	2109	2109	2736
3354 x 2286	1176	2279	2279	2279	2904
3659 x 1981	1266	2246	2246	2246	2870
3659 x 2136	1270	2246	2246	2246	2870
3659 x 2286	1276	2349	2349	2349	2972
3964 x 1981	1366	2313	2313	2313	2937
3964 x 2136	1370	2313	2313	2313	2937
3964 x 2286	1376	2349	2349	2349	2985
4269 x 1981	1466	2381	2381	2381	3003
4269 x 2136	1470	2381	2381	2381	3003
4574 x 1981	1566	2586	2586	2586	3208
4574 x 2136	1570	2586	2586	2586	3208
4879 x 1981	1666	2720	2720	2720	3347
4879 x 2136	1670	2720	2720	2720	3347

¹ Windows for Beaumont: Standard () , Diamond () , Cross () . Please state on order if clear or crystal panes.

Please note that doors with windows may have cross bracing or locking rods passing behind the windows depending upon size and gear type.

For further options please see page 15.

Double door

Nominal Door Size
Width x Height
(mm x mm)

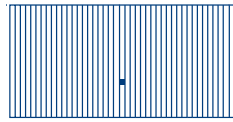

Carlton

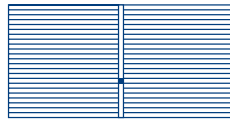

Horizon

	R	R
2745-3049 x 2137-2286	2483	-
3050-3354 x 1886-1981	2349	2381
3050-3354 x 1982-2136	2366	2398
3050-3354 x 2137-2286	2586	2619
3355-3659 x 1886-1981	2416	2449
3355-3659 x 1982-2136	2466	2499
3355-3659 x 2137-2286	2586	2619
3660-3967 x 1886-1981	2636	2670
3660-3967 x 1982-2136	2686	2720
3660-3967 x 2137-2286	2875	2906
3968-4269 x 1886-1981	2550	2586
3968-4269 x 1982-2136	2586	2619
4270-5000 x 1886-1981	2825	2855
4270-5000 x 1982-2136	2891	2925

Double door

Nominal Door Size
Width x Height
(mm x mm)

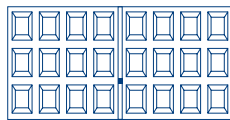

Georgian

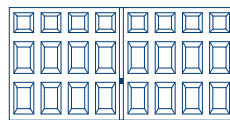

Beaumont

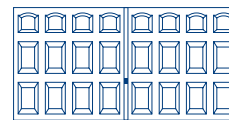

Cathedral

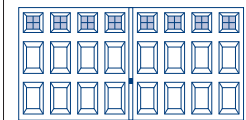

Beaumont with Windows¹

	R	R	R	R
2745-3049 x 2137-2286	2483	2483	2483	2911
3050-3354 x 1931-1981	2449	2449	2449	3075
3050-3354 x 1982-2136	2483	2483	2483	3109
3050-3354 x 2137-2286	2619	2619	2619	3247
3355-3659 x 1931-1981	2586	2586	2586	3208
3355-3659 x 1982-2136	2653	2653	2653	3278
3355-3659 x 2137-2286	2686	2686	2686	3312
3660-3967 x 1931-1981	2653	2653	2653	3482
3660-3967 x 1982-2136	2686	2686	2686	3518
3660-3967 x 2137-2286	2720	2720	2720	3553
3968-4269 x 1931-1981	2720	2720	2720	3553
3968-4269 x 1982-2136	2720	2720	2720	3553
4270-5000 x 1931-1981	3061	3061	3061	4100
4270-5000 x 1982-2136	3061	3061	3061	4100

¹ Windows for Beaumont: Standard (□), Diamond (◊), Cross (⊕). Please state on order if clear or crystal panes.

Orders for purpose made sizes will only be accepted as nominal door size for unframed version and overall frame size when ordering a framed version. Orders for purpose made framed doors will not be accepted as nominal door size.

Please note that doors with windows may have cross bracing or locking rods passing behind the windows depending upon size and gear type. For further options please see page 15.

Options	Single doors	Double doors
	add	add
Factory pre-framed standard single doors	168	-
Steel frame for standard double doors	-	252
Factory pre-framed purpose-made single doors (framed retractable purpose made doors require a 4 week lead-time)	189	-
Steel frame for purpose made double doors	-	280
Additional Lock Kit, C-type/ R-type (fitted onto door)	78	-
Retractable plus gear available on 1931, 1981 and 2136 mm high doors up to 2744 mm wide	80	-
For powder-coated doors ¹ : Moss Green (RAL 6005), Ruby Red (RAL 3003), Signal Blue (RAL 5005), Jet Black (RAL 9005), Steel Blue (RAL 5011), Light Ivory (RAL 1015), Pigeon Blue (RAL 5014), Fir Green (RAL 6009), Anthracite Grey (RAL 7016), Stone Grey (RAL 7030), Light Grey (RAL 7035), Slate Grey (RAL 7015), Agate Grey (RAL 7038), Window Grey (RAL 7040), Chartwell Green (BS 4800), Burgundy Brown ² , Golden Brown ² and Terra Brown (RAL 8028).	166	259
Coloured window frames to match door colour – Beaumont doors (price per window). Beaumont doors up to 3049 wide = 4 windows, between 3050 to 3964 = 6 windows, between 3965 to 4860 = 8 windows and over 4860 = 10 windows ² .	61 each	61 each
Coloured window frames to match door colour – Salisbury doors (price per door) ²	208	409
Black window panes for Salisbury doors (price per door)	47	88
Poly-wrapping	44	81
Diecast metal handles: brass effect, chrome effect, brushed steel and white	92	92
Bottom weatherseal, 2405 mm length (suitable for gaps up to 15 mm between the door and the floor level)	57	57
Bottom weatherseal, 3000 mm length (suitable for gaps up to 15 mm between the door and the floor level)	63	63
Surcharge on White RAL 9016 doors for colour steel frame in RAL colour not matching Garage door	166	259

¹ Please state coloured windows required on order. Coloured Beaumont with windows and Salisbury doors are supplied with white or brown window frames as standard.

² Colour match windows not available in Burgundy Brown or Golden Brown.

Please note that doors with windows may have cross bracing or locking rods passing behind the windows depending upon size and gear type.

Guardian Range

New Secured By Design certified Up & Over doors

These doors have been tested to the STS 202 Security Technical Specification and achieve Secured By Design accreditation. New lock body protection, anti-snap cylinder, high security bracing and improved lock security make these doors even more secure.

Information

Guardian Range doors come with a pre-fitted steel frame and cannot be fitted to a custom made timber frame.

There is no mechanism to unlock Guardian range doors from the inside.

Guardian Range doors are not suitable for automation. Only available with canopy or retractable lifting gear.

Retractable plus not available.

Window panes on Secured by Design Salisbury doors are black non-translucent.

Single door - standard sizes

Nominal Door Size
Width x Height
(mm x mm)

Size
Code

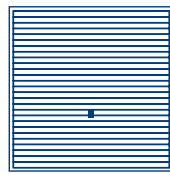

Horizon

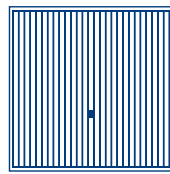

Carlton

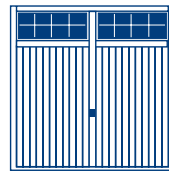

Salisbury

Nominal Door Size Width x Height (mm x mm)	Size Code	Horizon		Carlton		Salisbury	
		C	R	C	R	C	R
1984 x 1830	6660	1400	1449	1516	1565	-	-
1984 x 1905	6663	1400	1449	1516	1565	-	-
1984 x 1931	6664	1400	1449	1516	1565	-	-
1984 x 1981	6666	1361	1410	1470	1519	-	-
1984 x 2136	6670	1376	1425	1470	1519	-	-
2084 x 1931	61064	1376	1425	1470	1519	-	-
2084 x 1981	61066	1395	1444	1470	1519	-	-
2084 x 2136	61070	1424	1473	1485	1534	-	-
2134 x 1830	7060	1426	1475	1539	1588	-	-
2134 x 1905	7063	1426	1475	1539	1588	-	-
2134 x 1931	7064	1383	1432	1473	1522	2070	2119
2134 x 1981	7066	1291	1340	1442	1491	2070	2119
2134 x 2031	7068	1462	1511	1555	1604	-	-
2134 x 2136	7070	1396	1445	1479	1528	2085	2134
2134 x 2186	7072	-	1539	-	1628	-	-
2170 x 1931	7164	1462	1511	1534	1583	-	-
2170 x 1981	7166	1291	1340	1442	1491	-	-
2170 x 2036	7168	1462	1511	1555	1604	-	-
2170 x 2136	7170	1485	1534	1581	1630	-	-
2170 x 2186	7172	-	1550	-	1645	-	-
2224 x 1931	7364	1455	1504	1515	1564	-	-
2224 x 1981	7366	1462	1511	1519	1568	-	-
2224 x 2136	7370	1475	1524	1530	1579	-	-
2259 x 1931	7564	1502	1551	1565	1614	2126	2175
2259 x 1981	7566	1455	1504	1523	1572	2126	2175
2259 x 2036	7568	1579	1628	1644	1693	-	-
2259 x 2136	7570	1579	1628	1644	1693	2141	2190
2259 x 2286	7572	-	1644	-	1709	-	-
2284 x 1931	7664	1455	1504	1550	1599	2126	2175
2284 x 1981	7666	1455	1504	1550	1599	2126	2175
2284 x 2031	7668	1538	1587	1637	1686	-	-
2284 x 2136	7670	1581	1630	1644	1693	2141	2190
2284 x 2186	7672	-	-	-	1800	-	-
2439 x 1931	8064	-	-	-	1795	-	2288
2439 x 1981	8066	-	-	-	1795	-	2288
2439 x 2031	8068	-	-	-	1896	-	-
2439 x 2136	8070	-	-	-	1834	-	2306
2439 x 2186	8072	-	-	-	1937	-	-
2590 x 1981	8666	-	-	-	1898	-	-
2590 x 2136	8670	-	-	-	1953	-	-
2744 x 1981	9066	-	-	-	1993	-	-
2744 x 2136	9070	-	-	-	2071	-	-

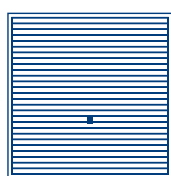
**Single door -
purpose-made sizes**Nominal Door Size
Width x Height
(mm x mm)

Horizon

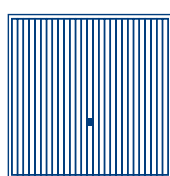

Carlton

		Horizon		Carlton	
		C	R	C	R
1985-2134	x 1830-1930	1717	1766	1760	1809
1985-2134	x 1931-1981	1785	1834	1831	1880
1985-2134	x 1982-2136	1885	1934	1909	1958
2135-2284	x 1830-1930	1785	1834	1812	1861
2135-2284	x 1931-1981	1885	1934	1885	1934
2135-2284	x 1982-2136	1963	2012	2008	2057
2285-2499	x 1830-1930	-	-	-	1957
2285-2499	x 1931-1981	-	-	-	2037
2285-2499	x 1982-2136	-	-	-	2113
2500-2590	x 1830-1930	-	-	-	2062
2500-2590	x 1931-1981	-	-	-	2125
2500-2590	x 1982-2136	-	-	-	2197
2591-2722	x 1830-1930	-	-	-	2123
2591-2722	x 1931-1981	-	-	-	2186
2591-2722	x 1982-2136	-	-	-	2298

Orders for purpose made sizes will only be accepted as overall frame size when ordering a framed version. Orders for purpose made framed doors will not be accepted as nominal door size.

Options for single doors

add

For powder coated doors: Moss Green (RAL 6005), Ruby Red (RAL 3003), Signal Blue (RAL 5005), Jet Black (RAL 9005), Steel Blue (RAL 5011), Light Ivory (RAL 1015), Pigeon Blue (RAL 5014), Fir Green (RAL 6009), Anthracite Grey (RAL 7016), Stone Grey (RAL 7030), Light Grey (RAL 7035), Slate Grey (RAL 7015), Agate Grey (RAL 7038), Window Grey (RAL 7040), Chartwell Green (BS 4800), Burgundy Brown², Golden Brown² and Terra Brown (RAL 8028).

166

Coloured window frames on Salisbury to match door colour¹

208

Poly-wrapping

44

¹ Colour match windows not available in Burgundy Brown or Golden Brown.



Secured by Design is an association focusing on the design of more secure homes and commercial properties.

Secured by Design is owned by the ACPO (Association of Chief Police Officers) and awards the Secured by Design status to products that pass their extensive testing procedures.

Design Range

Surface and finish

The Series 100 Design Range skins are built from four horizontal skins, whilst the Series 200 range is constructed from three vertical skins. Stainless steel elements on Garador design range doors are manufactured from high grade 2 mm thick steel with a brushed finish. The series 100 and 200 design range doors are also available without stainless steel elements. On Design Range doors a choice of any standard colour comes free of charge, please see page 19 for a choice of the 19 standard RAL colours available.

Please note: panel doors are produced with appearance in mind. This may result in some small gaps which could allow water ingress especially in exposed locations.

Handle

A new perfectly matched handle offers a quality feel everytime you open the door.

Terminology

Nominal Door Size: This is the actual door panel size plus the fitting tolerances. The nominal door size should be used for internal dimensions of a timber frame.

Size Code: This has traditionally been used to order doors. This may not be the actual door size.

Single door

Nominal Door Size
Width x Height
(mm x mm)

Size
Code

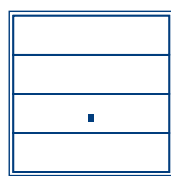

100

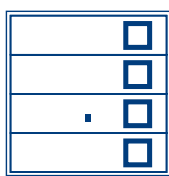

101

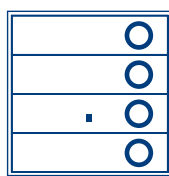

102

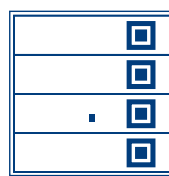

103

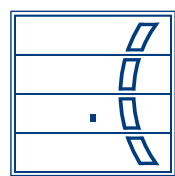

104

Nominal Door Size Width x Height (mm x mm)	Size Code	100		101		102		103		104	
		C	R	C	R	C	R	C	R	C	R
2134 x 1981	7066	1279	1328	1533	1582	1533	1582	1533	1582	1533	1582
2134 x 2136	7070	1363	1412	1617	1666	1617	1666	1617	1666	1617	1666
2259 x 1981	7566	1407	1456	1660	1709	1660	1709	1660	1709	1660	1709
2259 x 2136	7570	1490	1539	1746	1795	1746	1795	1746	1795	1746	1795
2284 x 1981	7666	1433	1482	1684	1733	1684	1733	1684	1733	1684	1733
2284 x 2136	7670	1516	1565	1770	1819	1770	1819	1770	1819	1770	1819
2439 x 1981	8066	1617	1666	1870	1919	1870	1919	1870	1919	1870	1919
2439 x 2136	8070	1701	1750	1956	2005	1956	2005	1956	2005	1956	2005

Single door

Nominal Door Size
Width x Height
(mm x mm)

Size
Code

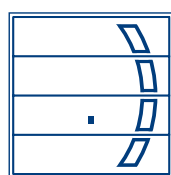

105

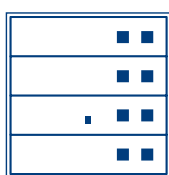

106

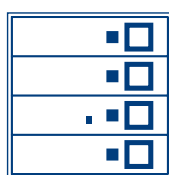

108

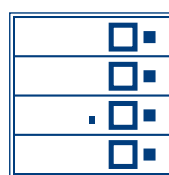

109

Nominal Door Size Width x Height (mm x mm)	Size Code	105		106		108		109	
		C	R	C	R	C	R	C	R
2134 x 1981	7066	1533	1582	1533	1582	1533	1582	1533	1582
2134 x 2136	7070	1617	1666	1617	1666	1617	1666	1617	1666
2259 x 1981	7566	1660	1709	1660	1709	1660	1709	1660	1709
2259 x 2136	7570	1746	1795	1746	1795	1746	1795	1746	1795
2284 x 1981	7666	1684	1733	1684	1733	1684	1733	1684	1733
2284 x 2136	7670	1770	1819	1770	1819	1770	1819	1770	1819
2439 x 1981	8066	1870	1919	1870	1919	1870	1919	1870	1919
2439 x 2136	8070	1956	2005	1956	2005	1956	2005	1956	2005

Single door

Nominal Door Size
Width x Height
(mm x mm)

Size
Code

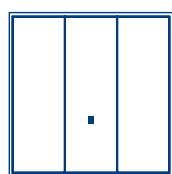

200

C

R

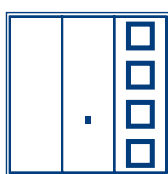

201

C

R

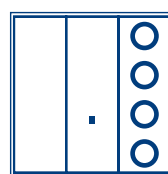

202

C

R

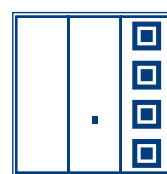

203

C

R

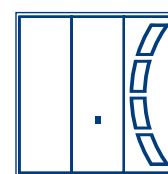

204

C

R

Nominal Door Size	Size Code	200 C	200 R	201 C	201 R	202 C	202 R	203 C	203 R	204 C	204 R
2134 x 1981	7066	1279	1328	1533	1582	1533	1582	1533	1582	1533	1582
2134 x 2136	7070	1363	1412	1617	1666	1617	1666	1617	1666	1617	1666
2259 x 1981	7566	1407	1456	1660	1709	1660	1709	1660	1709	1660	1709
2259 x 2136	7570	1490	1539	1746	1795	1746	1795	1746	1795	1746	1795
2284 x 1981	7666	1433	1482	1684	1733	1684	1733	1684	1733	1684	1733
2284 x 2136	7670	1516	1565	1770	1819	1770	1819	1770	1819	1770	1819
2439 x 1981	8066	1617	1666	1870	1919	1870	1919	1870	1919	1870	1919
2439 x 2136	8070	1701	1750	1956	2005	1956	2005	1956	2005	1956	2005

Single door

Nominal Door Size
Width x Height
(mm x mm)

Size
Code

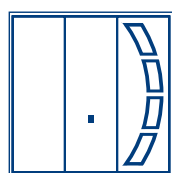

205

C

R

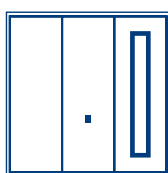

210

C

R

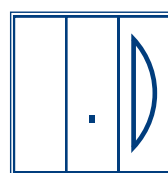

211

C

R

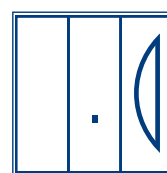

212

C

R

Nominal Door Size	Size Code	205 C	205 R	210 C	210 R	211 C	211 R	212 C	212 R
2134 x 1981	7066	1533	1582	1533	1582	1533	1582	1533	1582
2134 x 2136	7070	1617	1666	1617	1666	1617	1666	1617	1666
2259 x 1981	7566	1660	1709	1660	1709	1660	1709	1660	1709
2259 x 2136	7570	1746	1795	1746	1795	1746	1795	1746	1795
2284 x 1981	7666	1684	1733	1684	1733	1684	1733	1684	1733
2284 x 2136	7670	1770	1819	1770	1819	1770	1819	1770	1819
2439 x 1981	8066	1870	1919	1870	1919	1870	1919	1870	1919
2439 x 2136	8070	1956	2005	1956	2005	1956	2005	1956	2005

Options for single doors

add

Factory pre-fitted steel frame

168

Additional Lock Kit, C-type/ R-type (fitted onto door)

78

Retractable plus gear

80

Poly-wrapping

44

Please specify on order if you would like the design elements on the right or the left hand side of the door panel (viewed from outside).

Colour options on Design Range doors are free of charge. Available options are: White (RAL 9016), Terra Brown (RAL 8028), Moss Green (RAL 6005), Ruby Red (RAL 3003), Signal Blue (RAL 5005), Jet Black (RAL 9005), Steel Blue (RAL 5011), Light Ivory (RAL 1015), Pigeon Blue (RAL 5014), Fir Green (RAL 6009), Anthracite Grey (RAL 7016), Stone Grey (RAL 7030), Light Grey (RAL 7035), Slate Grey (RAL 7015), Agate Grey (RAL 7038), Window Grey (RAL 7040), Chartwell Green (BS 4800), Burgundy Brown and Golden Brown (solid).

GRP Premier Panel Doors

Surface

High gloss or woodgrain finish depending on door style.

GRP Premier doors are constructed as an infill panel and are fixed into a rigid box section chassis.

The infill has a flow coat to the inside face for a smoother finish and reduced translucency.

Please note: panel doors are produced with appearance in mind. This may result in some small gaps which could allow water ingress especially in exposed locations.

Standard colours

Arden and Stamford are available in Gloss White and Gloss Magnolia finish only. All other doors are available in the following range of woodgrain colours: White, Magnolia, Bleached Oak, Red Mahogany, Dark Mahogany, Light Oak, Dark Oak, Irish Oak, Honey Beech, Teak, Rosewood, Golden Brown, Ebony and Anthracite Grey.

Due to the production processes door colours may vary. Should you require matching doors please specify on your order.

Please note when trying to colour match garage doors with other UPVC products always check a colour sample first. The gel coats used in the process will not necessarily be a match and we will not guarantee a match with any other product (e.g. Rosewood GRP differs from Rosewood UPVC, and Dark Mahogany GRP may be a closer match).

Premium colours

Our GRP premium colour range includes Blue and Green. There is an additional surcharge for these colours, see page 24 for details.

Chassis colour

Traffic White (RAL 9016) for White Woodgrain and Gloss White doors, Black (RAL 9005) for Ebony coloured doors, Anthracite Grey (RAL 7016) for Anthracite Grey doors, Light Ivory (RAL 1015) for Magnolia Gloss and Magnolia doors, Fir Green (RAL 6009) for Green doors and Steel Blue (RAL 5011) for Blue doors.

Burgundy Brown will be used as the chassis colour for Red Mahogany, Dark Oak, Rosewood and Dark Mahogany.

All other doors will be supplied with a Terra Brown (RAL 8028) chassis.

Handle

Black handle and base plate as standard, optional handles available. Doors can be supplied undrilled and without handle and locking mechanism for use with electric operator. This must be requested at the time of order.

Certain panel configurations may only be available without handle or locking, therefore only suitable for electric operation (consult Garador sales office for exact details).

Terminology

Nominal Door Size: This is the actual door panel size plus the fitting tolerances. The nominal door size should be used for internal dimensions of a timber frame.

Size Code: This has traditionally been used to order doors. This may not be the actual door size.

Packaging

Supplied with front surface protection as standard.

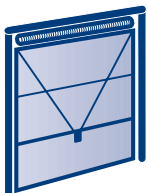

Canopy gearing (shown as C)

Canopy gear is available for all single doors providing a reliable and affordable gearing solution, with no tracks running back into the garage.

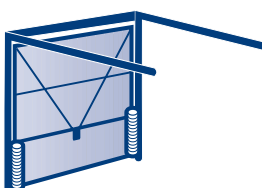

Retractable gearing (shown as R)

Retractable gear is available for all single and double doors providing a reliable and affordable gearing solution, with tracks running back into the garage.

Single door

Nominal Door Size
Width x Height
(mm x mm)

Size
Code

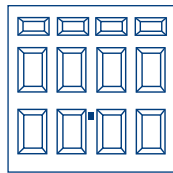

Arden

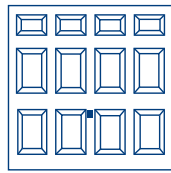

Kenmore

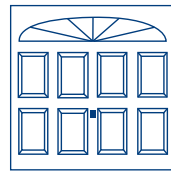

Stamford

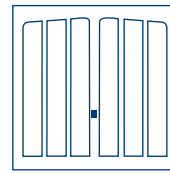

Penshurst

Nominal Door Size Width x Height (mm x mm)	Size Code	Arden		Kenmore		Stamford		Penshurst	
		C	R	C	R	C	R	C	R
2134 x 1981	7066	2560	2609	2612	2661	2688	2737	2771	2820
2134 x 2136	7070	2560	2609	2612	2661	2688	2737	2771	2820
2259 x 1981	7566	2678	2727	2747	2796	2796	2845	2986	3035
2259 x 2136	7570	2678	2727	2747	2796	2796	2845	2986	3035
2284 x 1981	7666	2699	2748	2771	2820	2827	2876	3015	3064
2284 x 2136	7670	2699	2748	2771	2820	2827	2876	3015	3064
2439 x 1981	8066	2949	2998	2980	3029	3060	3109	3208	3257
2439 x 2136	8070	2949	2998	2980	3029	3060	3109	3208	3257
2744 x 1981	9066	-	3286 ¹	-	3364 ¹	-	-	-	-
2744 x 2136	9070	-	3286 ¹	-	3364 ¹	-	-	-	-
3049 x 1981	1066	-	3607 ¹	-	3722 ¹	-	-	-	-
3049 x 2136	1070	-	3607 ¹	-	3722 ¹	-	-	-	-

¹ Doors only available with electric operation (Handle and Locking not available).

Single door

Nominal Door Size
Width x Height
(mm x mm)

Size
Code

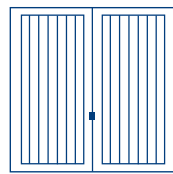

Swinton

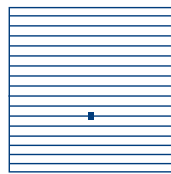

Glastonbury

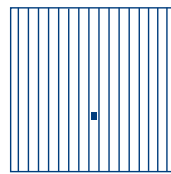

Somerset

Nominal Door Size Width x Height (mm x mm)	Size Code	Swinton		Glastonbury		Somerset	
		C	R	C	R	C	R
2134 x 1981	7066	2771	2820	2771	2820	2771	2820
2134 x 2136	7070	2771	2820	2771	2820	2771	2820
2259 x 1981	7566	2986	3035	2986	3035	2986	3035
2259 x 2136	7570	2986	3035	2986	3035	2986	3035
2284 x 1981	7666	3015	3064	3015	3064	3015	3064
2284 x 2136	7670	3015	3064	3015	3064	3015	3064
2439 x 1981	8066	3208	3257	-	-	3208	3257
2439 x 2136	8070	3208	3257	-	-	3208	3257
2744 x 1981	9066	-	-	-	-	-	3594
2744 x 2136	9070	-	-	-	-	-	3594
3049 x 1981	1066	-	-	-	-	-	3947
3049 x 2136	1070	-	-	-	-	-	3947

Please note that doors with windows may have cross bracing or locking rods passing behind the windows depending upon size and gear type.

For further options please see page 24.

Single door

Nominal Door Size
Width x Height
(mm x mm)

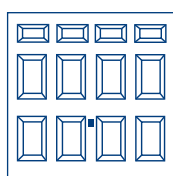

Arden

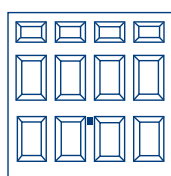

Kenmore

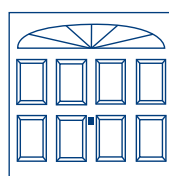

Stamford

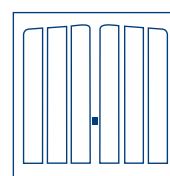

Penshurst

		Arden		Kenmore		Stamford		Penshurst	
		C	R	C	R	C	R	C	R
2032-2133	x 1931-1980	-	-	-	-	-	-	3060	3109
2032-2133	x 1981-2136	-	-	-	-	-	-	3060	3109
2032-2133	x 2137-2286	-	-	-	-	-	-	-	3535
2134-2439	x 1931-1980	-	-	-	-	-	-	3512	3561
2134-2439	x 1981-2136	3229	3278	3266	3315	3358	3407	3512	3561
2134-2439	x 2137-2286	-	3724	-	3769	-	-	-	4063
2440-2590	x 1931-1980	-	-	-	-	-	-	-	-
2440-2590	x 1981-2136	-	-	-	-	-	-	-	-
2440-2590	x 2137-2286	-	-	-	-	-	-	-	-
2591-2744	x 1931-1980	-	-	-	-	-	-	-	-
2591-2744	x 1981-2136	-	-	-	3761 ¹	-	-	-	-
2591-2744	x 2137-2286	-	-	-	-	-	-	-	-
2745-2896	x 1931-1980	-	-	-	-	-	-	-	-
2745-2896	x 1981-2136	-	4001 ¹	-	4110 ¹	-	-	-	-
2745-2896	x 2137-2286	-	-	-	-	-	-	-	-
2897-3049	x 1931-1980	-	-	-	-	-	-	-	-
2897-3049	x 1981-2136	-	4001 ¹	-	4110 ¹	-	-	-	-
2897-3049	x 2137-2286	-	-	-	-	-	-	-	-

¹ Doors only available with electric operation (Handle and Locking not available).

Single door

Nominal Door Size
Width x Height
(mm x mm)

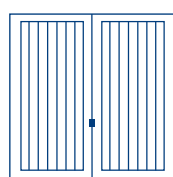

Swinton

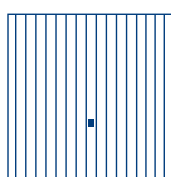

Somerset

		Swinton		Somerset	
		C	R	C	R
2259-2439	x 1981-2136	3512	3561	3512	3561
2259-2439	x 2150-2286	-	3802	-	3564
2440-2590	x 1931-1980	-	-	-	3617
2440-2590	x 1981-2136	-	-	-	3617
2440-2590	x 2137-2286	-	-	-	3617
2591-2744	x 1931-1980	-	-	-	3831
2591-2744	x 1981-2136	-	-	-	3831
2591-2744	x 2137-2286	-	-	-	3831
2745-2896	x 1931-1980	-	-	-	4134
2745-2896	x 1981-2136	-	-	-	4134
2745-2896	x 2137-2286	-	-	-	4134
2897-3049	x 1931-1980	-	-	-	4377
2897-3049	x 1981-2136	-	-	-	4377
2897-3049	x 2137-2286	-	-	-	4377

Orders for purpose made sizes will only be accepted as nominal door size for unframed version and overall frame size when ordering a framed version. Orders for purpose made framed doors will not be accepted as nominal door size. Please note that doors with windows may have cross bracing or locking rods passing behind the windows depending upon size and gear type. For further options please see page 24.

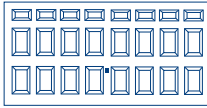
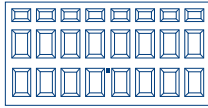
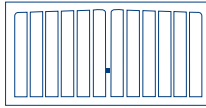
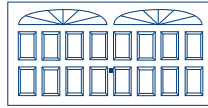
Double door					
Nominal Door Size Width x Height (mm x mm)	Size Code	Arden R	Kenmore R	Penshurst R	Stamford R
3354 x 1981	1166	3607	3751	-	-
3354 x 2136	1170	3607	3751	-	-
3354 x 2286	1176	3607	-	-	-
3659 x 1981	1266	3904 ¹	4075 ¹	-	-
3659 x 2136	1270	3904 ¹	4075 ¹	-	-
3659 x 2286	1276	3904	-	-	-
3964 x 1981	1366	4194 ¹	4401 ¹	-	-
3964 x 2136	1370	4194 ¹	4401 ¹	-	-
3964 x 2286	1376	4194	-	-	-
4269 x 1981	1466	4485	4738	4936	4954 ¹
4269 x 2136	1470	4485	4738	4936	4954 ¹
4269 x 2286	1476	4485	-	-	-

¹ Doors only available with electric operation (Handle and Locking not available).

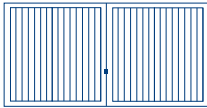
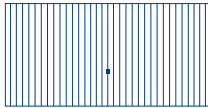
Double door			
Nominal Door Size Width x Height (mm x mm)	Size Code	Swinton R	Somerset R
3354 x 1981	1166	-	3751
3354 x 2136	1170	-	3751
3354 x 2286	1176	-	-
3659 x 1981	1266	-	4075
3659 x 2136	1270	-	4075
3659 x 2286	1276	-	-
3964 x 1981	1366	-	4401
3964 x 2136	1370	-	4401
3964 x 2286	1376	-	-
4269 x 1981	1466	-	4810
4269 x 2136	1470	4954	4810
4269 x 2286	1476	-	-

¹ Doors only available with electric operation (Handle and Locking not available).

Please note that doors with windows may have cross bracing or locking rods passing behind the windows depending upon size and gear type.

For further options please see page 24.

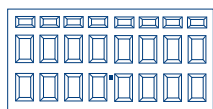
Double doorNominal Door Size
Width x Height
(mm x mm)

Arden

R

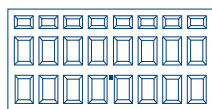

Kenmore

R

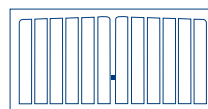

Penshurst

R

3050-3355	x	1981-2136	3853	4009	-
3050-3355	x	2137-2286	3994	-	-
3356-3660	x	1981-2136	4140 ¹	4335 ¹	-
3356-3660	x	2137-2286	4282	-	-
3661-3965	x	1981-2136	4431 ¹	4660 ¹	-
3661-3965	x	2137-2286	4574	-	-
3966-4117	x	1981-2136	4720 ¹	4972 ¹	-
3966-4117	x	2137-2286	4720	-	-
4118-4269	x	1981-2136	4720	4972	5178
4118-4269	x	2137-2286	4995	-	-

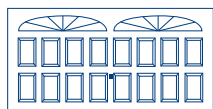
¹ Doors only available with electric operation (Handle and Locking not available).**Double door**Nominal Door Size
Width x Height
(mm x mm)

Stamford

R

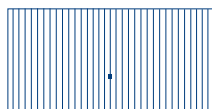

Somerset

R







3050-3355	x	1981-2136	-	4009
3050-3355	x	2137-2286	-	4009
3356-3660	x	1981-2136	-	4335
3356-3660	x	2137-2286	-	4335
3661-3965	x	1981-2136	-	4660
3661-3965	x	2137-2286	-	4660
3966-4117	x	1981-2136	-	4972
3966-4117	x	2137-2286	-	4972
4118-4269	x	1981-2136	5211 ¹	5178
4118-4269	x	2137-2286	-	5178

¹ Doors only available with electric operation (Handle and Locking not available).

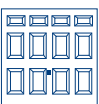
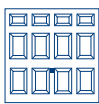





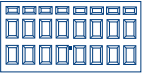

Orders for purpose made sizes will only be accepted as nominal door size for unframed version and overall frame size when ordering a framed version. Orders for purpose made framed doors will not be accepted as nominal door size.

Options

	Single doors add	Double doors add
Factory pre-framed standard single doors	168	-
Steel frame for standard double doors	-	252
Factory pre-framed purpose-made single doors	189	-
Steel frame for purpose-made double doors	-	280
Additional Lock Kit, C-type/ R-type (fitted onto door)	78	-
Retractable plus gear available on 1931, 1981 and 2136 mm high doors up to 2744 mm wide	80	-
Diecast metal handles with matching base plates: brass effect, brushed steel, chrome effect and white	117	117
Surcharge for Premium colours Green and Blue	384	763
Surcharge for steel frame in colour not matching garage door	168	-
Surcharge for colour steel frame on Matt or Gloss White Garage door	166	259

GRP Window options for standard and purpose-made single doors				Additional Cost (Width mm)	
				up to 2743	2744-3049
 Clear Perspex	X	X	X	208	308
 Stippled Perspex	X	X	X	209	308
 Stippled Perspex with diamond leading	-	X	X	342	503
 Stippled Perspex with square leading	-	X	X	342	503
 Black Non-Translucent	X	X	X	209	308
 Black Non-Translucent Perspex with border and diamond leading	-	X	X	342	503

Please state window code on order.

GRP Window options for standard and purpose-made double doors				Additional Cost (Width mm)	
				3354 - 3963	3964 - 4269
 Clear Perspex	X	X	X	361	411
 Stippled Perspex	X	X	X	361	411
 Stippled Perspex with diamond leading	-	X	X	589	706
 Stippled Perspex with square leading	-	X	X	589	706
 Black Non-Translucent	X	X	X	361	411
 Black Non-Translucent Perspex with border and diamond leading	-	X	X	589	706

Please state window code on order.

Please note that doors with windows may have cross bracing or locking rods passing behind the windows depending upon size and gear type.

Timber Panel Doors

Surface

Timber doors are supplied untreated and require immediate on-site finishing unless fully finished option specified. Timber is a natural material and therefore Garador cannot guarantee to be able to produce matching timber garage doors. Chassis colours will be Brown (RAL 8028) on all timber doors

Please note: panel doors are produced with appearance in mind. This may result in some small gaps which could allow water ingress especially in exposed locations. All Garador timber garage doors are plywood backed, the timber boards are not visible from the inside of the garage door.

Handle

Black handle and base plate supplied as standard, optional handles available. Doors can alternatively be supplied undrilled and without handle and locking mechanism for use with electric operator.

Packaging

Supplied with front surface protection as standard.

Terminology

Nominal Door Size: This is the actual door panel size plus the fitting tolerances. The nominal door size should be used for internal dimensions of a timber frame.

Size Code: This has traditionally been used to order doors. This may not be the actual door size.

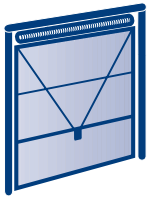

Canopy gearing (shown as C)

Canopy gear is available for all single doors providing a reliable and affordable gearing solution, with no tracks running back into the garage.

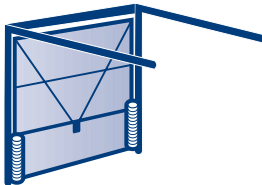

Retractable gearing (shown as R)

Retractable gear is available for all single and double doors providing a reliable and affordable gearing solution, with tracks running back into the garage.

Single door

Nominal Door Size
Width x Height
(mm x mm)

Size
Code

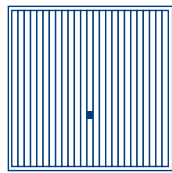

Vertical Timber

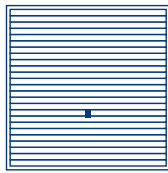

Horizontal Timber

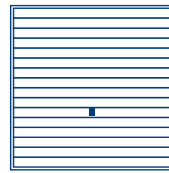

Countryman

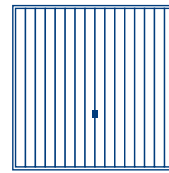

Hampton

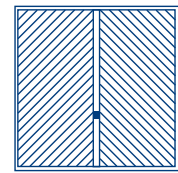

Chevron Timber

Nominal Door Size Width x Height (mm x mm)	Size Code	Vertical Timber		Horizontal Timber		Countryman		Hampton		Chevron Timber	
		C	R	C	R	C	R	C	R	C	R
2134 x 1981	7066	2657	2706	2796	2845	3318	3367	3318	3367	3950	3999
2134 x 2136	7070	2683	2732	2820	2869	3345	3394	3345	3394	4014	4063
2134 x 2286	7076	-	3036	-	3189	-	3762	-	3762	-	4237
2259 x 1981	7566	2796	2845	2941	2990	3490	3539	3490	3539	4215	4264
2259 x 2136	7570	2821	2870	2969	3018	3520	3569	3520	3569	4235	4284
2284 x 1981	7666	2796	2845	3222	3271	3490	3539	3490	3539	4215	4264
2284 x 2136	7670	2821	2870	2969	3018	3520	3569	3520	3569	4235	4284
2284 x 2286	7676	-	3149	-	3312	-	3774	-	3774	-	4443
2439 x 1981	8066	2959	3008	3115	3164	3689	3738	3689	3738	4354	4403
2439 x 2136	8070	2981	3030	3137	3186	3718	3767	3718	3767	4378	4427
2439 x 2286	8076	-	3341	-	3505	-	3999	-	3999	-	4562
2744 x 1981	9066	-	3487	-	3664	-	4163	-	4163	-	4855
2744 x 2136	9070	-	3510	-	3685	-	4208	-	4208	-	4924
2744 x 2286	9076	-	3830	-	4028	-	4505	-	4505	-	5089
3049 x 1981	1066	-	4036	-	4235	-	4702	-	4702	-	5450
3049 x 2136	1070	-	4073	-	4281	-	4741	-	4741	-	5493

Single door

Nominal Door Size
Width x Height
(mm x mm)

Size
Code

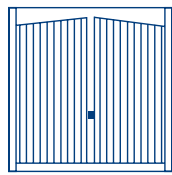

Barrington

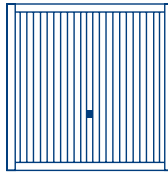

Kingsbury

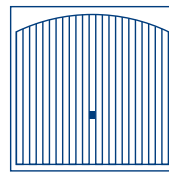

Adlington



Ashton¹

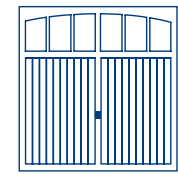

Rochdale¹

Nominal Door Size Width x Height (mm x mm)	Size Code	Barrington		Kingsbury		Adlington		Ashton ¹		Rochdale ¹	
		C	R	C	R	C	R	C	R	C	R
2134 x 1981	7066	3373	3422	3345	3394	3040	3089	3950	3999	3992	4041
2134 x 2136	7070	3395	3444	3372	3421	3040	3089	4014	4063	4019	4068
2134 x 2286	7076	-	3761	-	3728	-	3360	-	4237	-	4288
2259 x 1981	7566	3508	3557	3478	3527	3172	3221	4215	4264	4138	4187
2259 x 2136	7570	3529	3578	3505	3554	3192	3241	4235	4284	4158	4207
2284 x 1981	7666	3508	3557	3478	3527	3172	3221	4215	4264	4138	4187
2284 x 2136	7670	3529	3578	3505	3554	3192	3241	4235	4284	4158	4207
2284 x 2286	7676	-	3885	-	3857	-	3510	-	4443	-	4369
2439 x 1981	8066	3630	3679	3599	3648	3490	3539	4354	4403	4270	4319
2439 x 2136	8070	3654	3703	3626	3675	3490	3539	4378	4427	4305	4354
2439 x 2286	8076	-	3999	-	3965	-	3576	-	4562	-	4477
2744 x 1981	9066	-	4141	-	4002	-	3719	-	4855	-	4885
2744 x 2136	9070	-	4178	-	4036	-	3719	-	4924	-	4964
2744 x 2286	9076	-	4503	-	4369	-	4014	-	5089	-	5120
3049 x 1981	1066	-	4683	-	4545	-	4020	-	5450	-	5491
3049 x 2136	1070	-	4722	-	4582	-	4020	-	5493	-	5529

¹ Ashton and Rochdale doors may have cross bracing and / or locking rods behind the windows depending upon the size and gear type.

For further options please see page 35.

Single door

Nominal Door Size
Width x Height
(mm x mm)

Size
Code

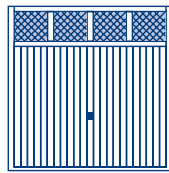

Sandhurst¹



Shaftesbury

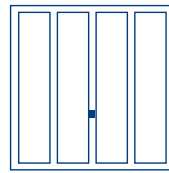

Grantham

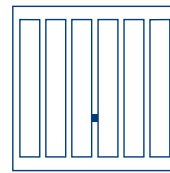

Seymour

Nominal Door Size Width x Height (mm x mm)	Size Code	Sandhurst ¹		Shaftesbury		Grantham		Seymour	
		C	R	C	R	C	R	C	R
2134 x 1981	7066	3870	3919	2999	3048	2019	2068	2864	2913
2134 x 2136	7070	3894	3943	3016	3065	2019	2068	2891	2940
2134 x 2286	7076	-	4158	-	3244	-	2226	-	3109
2259 x 1981	7566	4013	4062	3056	3105	2150	2199	2926	2975
2259 x 2136	7570	4036	4085	3077	3126	2150	2199	2949	2998
2284 x 1981	7666	4013	4062	3056	3105	2150	2199	2926	2975
2284 x 2136	7670	4036	4085	3077	3126	2150	2199	2949	2998
2284 x 2286	7676	-	4244	-	3286	-	2379	-	3155
2439 x 1981	8066	4146	4195	3107	3156	2232	2281	2975	3024
2439 x 2136	8070	4179	4228	3134	3183	2232	2281	2999	3048
2439 x 2286	8076	-	4353	-	3315	-	2474	-	3183
2744 x 1981	9066	-	4697	-	3761	-	2534	-	3600
2744 x 2136	9070	-	4775	-	3792	-	2534	-	3626
2744 x 2286	9076	-	4935	-	3967	-	2709	-	3777
3049 x 1981	1066	-	5301	-	4228	-	2753	-	4057
3049 x 2136	1070	-	5339	-	4268	-	2753	-	4060

¹ Sandhurst doors may have cross bracing and/or locking rods behind the windows depending upon the size and gear type.

Single door

Nominal Door Size
Width x Height
(mm x mm)

Size
Code

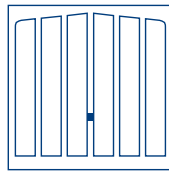

Tudor

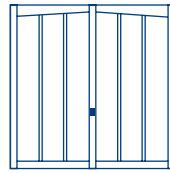

Bosworth

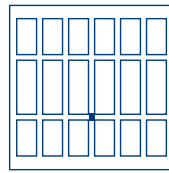

Wolsley

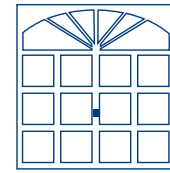

Hinton²

Nominal Door Size Width x Height (mm x mm)	Size Code	Tudor		Bosworth		Wolsley		Hinton ²	
		C	R	C	R	C	R	C	R
2134 x 1981	7066	2999	3048	3037	3086	2996	3045	4154	4203
2134 x 2136	7070	3016	3065	3057	3106	3014	3063	4180	4229
2134 x 2286	7076	-	3244	-	3283	-	3240	-	4406
2259 x 1981	7566	3056	3105	3098	3147	3053	3102	4414	4463
2259 x 2136	7570	3077	3126	3120	3169	3073	3122	4439	4488
2284 x 1981	7666	3056	3105	3098	3147	3053	3102	4414	4463
2284 x 2136	7670	3077	3126	3120	3169	3073	3122	4439	4488
2284 x 2286	7676	-	3286	-	3330	-	3284	-	4642
2439 x 1981	8066	3107	3156	3147	3196	3104	3153	4544	4593
2439 x 2136	8070	3134	3183	3167	3216	3125	3174	4573	4622
2439 x 2286	8076	-	3315	-	3356	-	3313	-	4752
2744 x 1981	9066	-	3761	-	3800	-	3667	-	5132
2744 x 2136	9070	-	3792	-	3826	-	3695	-	5160
2744 x 2286	9076	-	3967	-	4004	-	3846	-	5331
3049 x 1981	1066	-	4228	-	4268	-	4097	-	5798
3049 x 2136	1070	-	4268	-	4305	-	4101	-	5832

² Hinton doors may have cross bracing and/or locking rods behind the windows depending upon the size and gear type.

For further options please see page 35.

Single door

Nominal Door Size
Width x Height
(mm x mm)

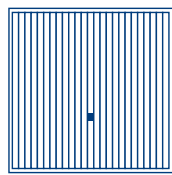

Vertical Timber

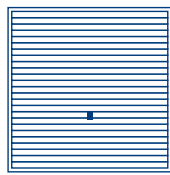

Horizontal Timber

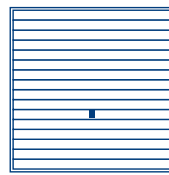

Countryman

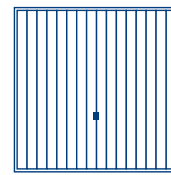

Hampton

		Vertical Timber		Horizontal Timber		Countryman		Hampton	
		C	R	C	R	C	R	C	R
1930-1984	x 1931-1981	2892	2941	3039	3088	4047	4096	4047	4096
1930-1984	x 1982-2136	2910	2959	3062	3111	4163	4212	4163	4212
1930-1984	x 2137-2286	-	3261	-	3425	-	4509	-	4509
1930-1984	x 2287-2439	-	3341	-	3505	-	4836	-	4836
1985-2284	x 1931-1981	3023	3072	3181	3230	4264	4313	4264	4313
1985-2284	x 1982-2136	3048	3097	3205	3254	4398	4447	4398	4447
1985-2284	x 2137-2286	-	3373	-	3540	-	4736	-	4736
1985-2284	x 2287-2439	-	3453	-	3623	-	5125	-	5125
2285-2439	x 1931-1981	3183 ¹	3232	3351 ¹	3400	4325 ¹	4374	4325 ¹	4374
2285-2439	x 1982-2136	3205 ¹	3254	3373 ¹	3422	4455 ¹	4504	4455 ¹	4504
2285-2439	x 2137-2286	-	3559	-	-	-	-	-	-
2285-2439	x 2287-2439	-	3695	-	-	-	-	-	-
2440-2744	x 1931-1981	-	3703	-	-	-	-	-	-
2440-2744	x 1982-2136	-	3728	-	-	-	-	-	-
2440-2744	x 2137-2286	-	4043	-	-	-	-	-	-
2440-2744	x 2287-2439	-	4154	-	-	-	-	-	-
2745-3049	x 1931-1981	-	4239	-	-	-	-	-	-
2745-3049	x 1982-2136	-	4283	-	-	-	-	-	-

¹ These doors are not available over 2438 mm wide.

Single door

Nominal Door Size
Width x Height
(mm x mm)

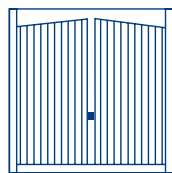

Barrington

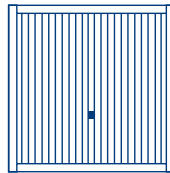

Kingsbury

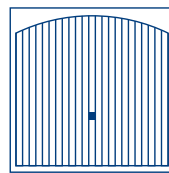

Adlington



Ashton²

		Barrington		Kingsbury		Adlington		Ashton ²	
		C	R	C	R	C	R	C	R
1930-1984	x 1931-1981	3657	3706	3631	3680	3120	3169	4247	4296
1930-1984	x 1982-2136	3678	3727	3656	3705	3142	3191	4270	4319
1930-1984	x 2137-2286	-	4047	-	4013	-	3490	-	4628
1930-1984	x 2287-2439	-	4122	-	4101	-	3568	-	4716
1985-2284	x 1931-1981	3788	3837	3765	3814	3256	3305	4382	4431
1985-2284	x 1982-2136	3814	3863	3785	3834	3279	3328	4403	4452
1985-2284	x 2137-2286	-	4176	-	4141	-	3606	-	4757
1985-2284	x 2287-2439	-	4249	-	4228	-	3679	-	4844
2285-2439	x 1931-1981	3912 ¹	3961	3882 ¹	3931	3414 ¹	3463	4500	4549
2285-2439	x 1982-2136	3933 ¹	3982	3909 ¹	3958	3437 ¹	3486	4526	4575
2285-2439	x 2137-2286	-	4285	-	4248	-	3792	-	4866
2285-2439	x 2287-2439	-	4391	-	4369	-	3924	-	4985
2440-2744	x 1931-1981	-	4427	-	4289	-	3935	-	4906
2440-2744	x 1982-2136	-	4458	-	4322	-	3953	-	4935
2440-2744	x 2137-2286	-	4795	-	4656	-	4276	-	5271
2440-2744	x 2287-2439	-	4900	-	4763	-	4384	-	5379
2745-3049	x 1931-1981	-	4968	-	4830	-	4472	-	5446
2745-3049	x 1982-2136	-	5011	-	4868	-	4509	-	5483

¹ These doors are not available over 2438 mm wide.

² Ashton doors may have cross bracing and / or locking rods behind the windows depending upon the size and gear type.

Orders for purpose made sizes will only be accepted as nominal door size for unframed version and overall frame size when ordering a framed version. Orders for purpose made framed doors will not be accepted as nominal door size. For further options please see page 35.

Single door

Nominal Door Size
Width x Height
(mm x mm)

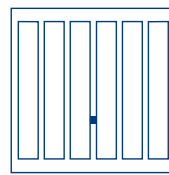
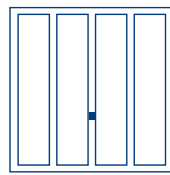

		Shaftesbury		Grantham		Seymour	
		C	R	C	R	C	R
1930-1984	x 1931-1981	3148	3197	2643	2692	3148	3197
1930-1984	x 1982-2136	3172	3221	2666	2715	3172	3221
1930-1984	x 2137-2286	-	3395	-	2893	-	3395
1930-1984	x 2287-2439	-	3502	-	2997	-	3502
1985-2284	x 1931-1981	3207	3256	2705	2754	3207	3256
1985-2284	x 1982-2136	3235	3284	2730	2779	3235	3284
1985-2284	x 2137-2286	-	3441	-	2940	-	3441
1985-2284	x 2287-2439	-	3543	-	3041	-	3543
2285-2439	x 1931-1981	3261 ¹	3310	2759 ¹	2808	3261 ¹	3310
2285-2439	x 1982-2136	3283 ¹	3332	2778 ¹	2827	3283 ¹	3332
2285-2439	x 2137-2286	-	3469	-	2965	-	3469
2285-2439	x 2287-2439	-	3618	-	3111	-	3618
2440-2744	x 1931-1981	-	3882	-	3379	-	3882
2440-2744	x 1982-2136	-	3912	-	3409	-	3912
2440-2744	x 2137-2286	-	4061	-	3559	-	4061
2440-2744	x 2287-2439	-	4176	-	3668	-	4176
2745-3049	x 1931-1981	-	4344	-	3841	-	4344
2745-3049	x 1982-2136	-	4345	-	3842	-	4345

¹ These doors are not available over 2438 mm wide.

Single door

Nominal Door Size
Width x Height
(mm x mm)

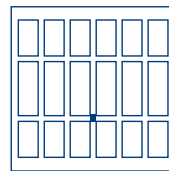
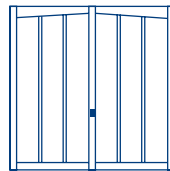
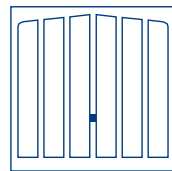

		Tudor		Bosworth		Wolsey	
		C	R	C	R	C	R
1930-1984	x 1931-1981	3283	3332	3320	3369	3277	3326
1930-1984	x 1982-2136	3302	3351	3344	3393	3299	3348
1930-1984	x 2137-2286	-	3526	-	3567	-	3522
1930-1984	x 2287-2439	-	3631	-	3674	-	3638
1985-2284	x 1931-1981	3343	3392	3382	3431	3339	3388
1985-2284	x 1982-2136	3368	3417	3404	3453	3360	3409
1985-2284	x 2137-2286	-	3574	-	3616	-	3568
1985-2284	x 2287-2439	-	3678	-	3719	-	3687
2285-2439	x 1931-1981	3393 ¹	3442	3429 ¹	3478	3388 ¹	3437
2285-2439	x 1982-2136	3414 ¹	3463	3454 ¹	3503	3412 ¹	3461
2285-2439	x 2137-2286	-	3602	-	3636	-	3599
2285-2439	x 2287-2439	-	3804	-	3842	-	3759
2440-2744	x 1931-1981	-	4047	-	4083	-	3950
2440-2744	x 1982-2136	-	4073	-	4115	-	3980
2440-2744	x 2137-2286	-	4249	-	4292	-	4130
2440-2744	x 2287-2439	-	4360	-	4401	-	4239
2745-3049	x 1931-1981	-	4514	-	4555	-	4384
2745-3049	x 1982-2136	-	4555	-	4592	-	4387

¹ These doors are not available over 2438 mm wide.

Orders for purpose made sizes will only be accepted as nominal door size for unframed version and overall frame size when ordering a framed version. Orders for purpose made framed doors will not be accepted as nominal door size.

For further options please see page 35.

Double door

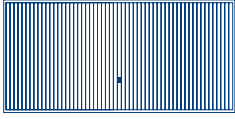
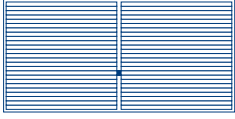
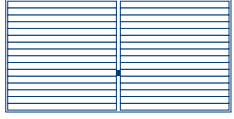
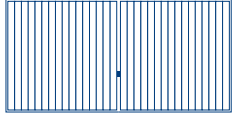
Nominal Door Size Width x Height (mm x mm)	Size Code				
		Vertical Timber	Horizontal Timber	Countryman	Hampton
		R	R	R	R
3049 x 2286	1076	4581	4641	5931	5931
3354 x 1981	1166	4581	4642	5871	5871
3354 x 2136	1170	4710	4774	5996	5996
3354 x 2286	1176	5093	5160	6502	6502
3659 x 1981	1266	5162	5233	6534	6534
3659 x 2136	1270	5296	5362	6661	6661
3659 x 2286	1276	5762	5837	7273	7273
3964 x 1981	1366	6102	6190	7200	7200
3964 x 2136	1370	6295	6382	7394	7394
3964 x 2286	1376	6831	6922	8040	8040
4269 x 1981	1466	5971	6059	7416	7416
4269 x 2136	1470	6102	6190	7543	7543
4574 x 1981	1566	6743	6836	-	-
4574 x 2136	1570	6935	7024	-	-
4879 x 1981	1666	7354	7452	-	-
4879 x 2136	1670	7417	7515	-	-

Double door

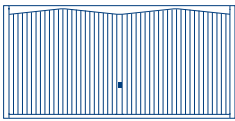
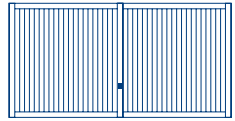
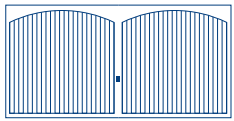
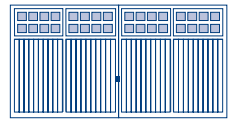
Nominal Door Size Width x Height (mm x mm)	Size Code				
		Barrington	Kingsbury	Adlington	Ashton ¹
		R	R	R	R
3049 x 2286	1076	5449	5197	5089	6054
3354 x 1981	1166	5408	5183	4992	5875
3354 x 2136	1170	5537	5311	5115	6002
3354 x 2286	1176	6002	5756	5543	6507
3659 x 1981	1266	6021	5793	5527	6747
3659 x 2136	1270	6151	5923	5653	6877
3659 x 2286	1276	6713	6492	6164	7512
3964 x 1981	1366	7006	6857	6691	7915
3964 x 2136	1370	7200	7049	6885	8109
3964 x 2286	1376	7826	7663	7483	8824
4269 x 1981	1466	6877	6729	6563	7787
4269 x 2136	1470	7006	6857	6691	7915
4574 x 1981	1566	7644	7546	-	8581
4574 x 2136	1570	7837	7739	-	8771
4879 x 1981	1666	8254	8159	-	9291
4879 x 2136	1670	8322	8224	-	9353

¹ Ashton doors may have cross bracing and/or locking rods behind the windows depending upon the size and gear type.

For further options please see page 35.

Double door

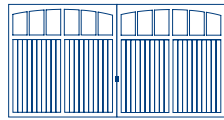
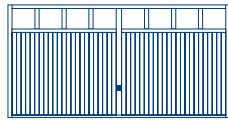
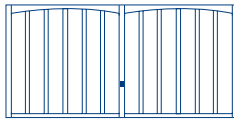
Nominal Door Size Width x Height (mm x mm)	Size Code			
		Rochdale ^{1,2}	Sandhurst ¹	Shaftesbury
		R	R	R
3049 x 2286	1076	6404	5629	4425
3354 x 1981	1166	6194	5593	4369
3354 x 2136	1170	6324	5721	4497
3354 x 2286	1176	6864	6205	4858
3659 x 1981	1266	7067	6309	4848
3659 x 2136	1270	7200	6439	4976
3659 x 2286	1276	7864	7024	5415
3964 x 1981	1366	8238	7364	5646
3964 x 2136	1370	8433	7553	5838
3964 x 2286	1376	9172	8219	6324
4269 x 1981	1466	8109	7231	5518
4269 x 2136	1470	8238	7364	5646
4574 x 1981	1566	9178	8224	6324
4574 x 2136	1570	9372	8420	6516
4879 x 1981	1666	9805	9124	7031
4879 x 2136	1670	9867	9192	7099

¹ Rochdale and Sandhurst doors may have cross bracing and/or locking rods behind the windows depending upon the size and gear type.

² Rochdale doors up to 3659 mm wide will be manufactured with one arch not the two as shown above.

Double door

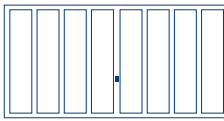
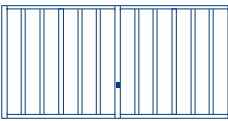
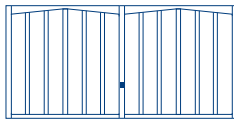
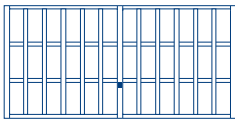
Nominal Door Size Width x Height (mm x mm)	Size Code				
		Grantham	Seymour	Tudor	Wolsey
		R	R	R	R
3049 x 2286	1076	3873	4381	4425	4968
3354 x 1981	1166	3793	4241	4369	4917
3354 x 2136	1170	3920	4369	4497	5047
3354 x 2286	1176	4224	4716	4858	5408
3659 x 1981	1266	4288	4786	4848	5397
3659 x 2136	1270	4417	4912	4976	5527
3659 x 2286	1276	4799	5349	5415	5961
3964 x 1981	1366	4799	5579	5646	6195
3964 x 2136	1370	4992	5774	5838	6389
3964 x 2286	1376	5389	6258	6324	6871
4269 x 1981	1466	4669	5449	5518	6067
4269 x 2136	1470	4799	5579	5646	6195
4574 x 1981	1566	-	-	6324	6871
4574 x 2136	1570	-	-	6516	7063
4879 x 1981	1666	-	-	7031	7582
4879 x 2136	1670	-	-	7099	7644

For further options please see page 35.

Double door

Nominal Door Size
Width x Height
(mm x mm)

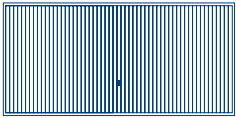
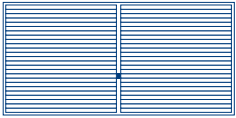
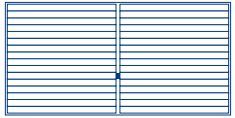
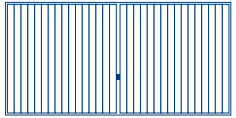
				
	Vertical Timber	Horizontal Timber	Countryman	Hampton
	R	R	R	R
2745-3049 x 2137-2286	-	-	-	-
3050-3659 x 1931-1981	5678	5756	6970	6970
3050-3659 x 1982-2136	5820	5898	7109	7109
3050-3659 x 2137-2286	6336	6422	7766	7766
3660-4269 x 1931-1981	6922	7019	8256	8256
3660-4269 x 1982-2136	7140	7231	8468	8468
3660-4269 x 2137-2286	7494	7594	8892	8892
4270-5000 x 1931-1981	8090	8194	-	-
4270-5000 x 1982-2136	8159	8265	-	-

Double door

Nominal Door Size
Width x Height
(mm x mm)

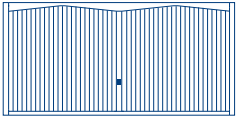
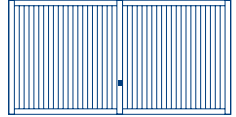
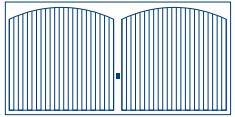
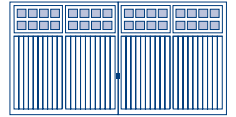
				
	Barrington	Kingsbury	Adlington	Ashton ¹
	R	R	R	R
2745-3049 x 2137-2286	-	-	-	6652
3050-3659 x 1931-1981	6621	6375	6073	7420
3050-3659 x 1982-2136	6763	6516	6216	7562
3050-3659 x 2137-2286	7382	7140	6775	8256
3660-4269 x 1931-1981	7918	7760	7575	8918
3660-4269 x 1982-2136	8131	7969	7786	9129
3660-4269 x 2137-2286	8537	8364	8174	9585
4270-5000 x 1931-1981	9081	8976	-	10214
4270-5000 x 1982-2136	9155	9045	-	10285

¹ Ashton doors may have cross bracing and/or locking rods behind the windows depending upon the size and gear type.

Orders for purpose made sizes will only be accepted as nominal door size for unframed version and overall frame size when ordering a framed version. Orders for purpose made framed doors will not be accepted as nominal door size.

For further options please see page 35.

Double door

Nominal Door Size
Width x Height
(mm x mm)

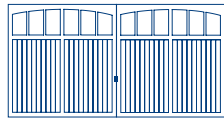

Rochdale^{1,2}

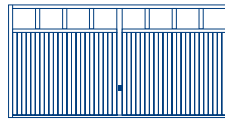

Sandhurst¹

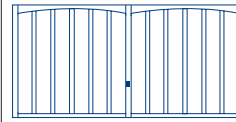

Shaftesbury

	R	R	R
2745-3049 x 2137-2286	7044	6190	4859
2745-3049 x 2287-2439	7401	6499	5107
3050-3659 x 1931-1981	7776	6941	5331
3050-3659 x 1982-2136	7918	7083	5473
3050-3659 x 2137-2286	8648	7727	5956
3050-3659 x 2287-2439	9076	8112	6253
3660-4269 x 1931-1981	9274	8309	6423
3660-4269 x 1982-2136	9486	8521	6637
3660-4269 x 2137-2286	9959	8945	6969
3660-4269 x 2287-2439	10433	9372	7297
4270-5000 x 1931-1981	10784	10039	7733
4270-5000 x 1982-2136	10853	10108	7806

¹ Rochdale and Sandhurst doors may have cross bracing and/or locking rods behind the windows depending upon the size and gear type.

² Rochdale doors up to 3659 mm wide will be manufactured with one arch not the two as shown above.

Double door

Nominal Door Size
Width x Height
(mm x mm)

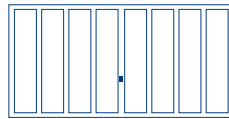

Grantham

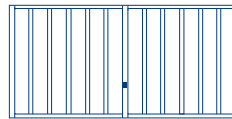

Seymour

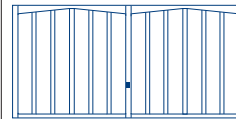

Tudor





Wolsey

	R	R	R	R
2745-3049 x 2137-2286	4258	4818	4859	5409
2745-3049 x 2287-2439	4473	5061	5107	5654
3050-3659 x 1931-1981	4711	5259	5331	5880
3050-3659 x 1982-2136	4856	5402	5473	6021
3050-3659 x 2137-2286	5273	5885	5956	6502
3050-3659 x 2287-2439	5537	6178	6253	6796
3660-4269 x 1931-1981	5486	6350	6423	6972
3660-4269 x 1982-2136	5697	6566	6637	7180
3660-4269 x 2137-2286	5986	6893	6969	7515
3660-4269 x 2287-2439	6271	7221	7297	7846
4270-5000 x 1931-1981	-	-	7733	8281
4270-5000 x 1982-2136	-	-	7806	8351

Orders for purpose made sizes will only be accepted as nominal door size for unframed version and overall frame size when ordering a framed version. Orders for purpose made framed doors will not be accepted as nominal door size.

For further options please see page 35.

Timber door window options Prices in £ stated per door						
	Standard		Georgian ¹		Diagonal ¹	
	Single doors	Double doors	Single doors	Double doors	Single doors	Double doors
Plain	no on-cost	no on-cost	160	221	160	221
Crystal	no on-cost	no on-cost	160	221	160	221

¹ Only available on Sandhurst.

Windows are manufactured from 4 mm acrylic panes. Please state on order if clear or stippled panes required.

Options	Single doors	Double doors
	add	add
Factory pre-framed standard single doors	168	-
Steel frame for standard double doors	-	252
Factory pre-framed purpose-made single doors	189	-
Steel frame for purpose-made double doors	-	280
Additional Lock Kit, C-type/ R-type (fitted onto door)	78	-
Factory fully finished stain in Light Oak, Antique Oak, Mahogany, Walnut, Chestnut and Ebony	219	323
Factory white primer ready for on-site painting	296	452
Factory fully finished painting (any RAL colour timber only)	490	849
Diecast metal handles with matching base plates: brass effect, chrome effect, brushed steel and white	117	117
Bottom weatherseal, 2405 mm length (suitable for gaps up to 15 mm between the door and the floor level)	57	57
Bottom weatherseal, 3000 mm length (suitable for gaps up to 15 mm between the door and the floor level)	63	63
Surcharge for colour steel Chassis and/or frame finished in RAL colour (no additional charge for Brown RAL8028 or White RAL9016 chassis and frame)	166	259

Please note, retractable plus lifting gear is not available on timber up and over garage doors.

Steel and Timber Garage Side Doors

Surface

Steel doors constructed around a strong steel box section chassis in Traffic White (RAL 9016) as standard. Timber doors constructed using timber, built around a strong steel box section chassis. A range of stain options are available. All Garador timber garage side doors are plywood backed, the timber boards are not visible from the inside of the garage door.

Handle







Supplied with lever/lever handle on left side (viewed outside)

Terminology

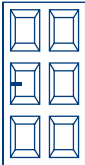
Nominal Door Size: This is the actual door panel size plus the fitting tolerances. The nominal door size should be used for internal dimensions of a timber frame.

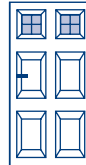
Size Code: This has traditionally been used to order doors. This may not be the actual door size.

Steel door - standard sizes





Nominal Door Size Width x Height (mm x mm)	Overall frame size (between fix) ¹ Width x Height (mm x mm)	Size Code							
			Georgian	Beaumont	Cathedral	Beaumont with Windows ²	Carlton	Ascot	Windsor
732 x 1905	882 x 1991	2664	1033 ³	1033 ³	1033 ³	1138 ³	854	1033	1033
732 x 1955	882 x 2041	2666	1052 ³	1052 ³	1052 ³	1156 ³	872	1052	1052
732 x 2110	882 x 2196	2670	1078 ³	1078 ³	1078 ³	1184 ³	897	1078	1078
884 x 1905	1034 x 1991	3064	1069 ³	1069 ³	1069 ³	1174 ³	887	1069	1069
884 x 1955	1034 x 2041	3066	1089 ³	1089 ³	1089 ³	1191 ³	908	1089	1089
884 x 2110	1034 x 2196	3070	1117 ³	1117 ³	1117 ³	1222 ³	936	1117	1117
1037 x 1905	1187 x 1991	3664	1105	1105	1105	1212	924	1105	1105
1037 x 1955	1187 x 2041	3666	1127	1127	1127	1228	945	1127	1127
1037 x 2110	1187 x 2196	3670	1150	1150	1150	1257	970	1150	1150
1170 x 1905	1320 x 1991	4064	1142	1142	1142	1244	960	1142	1142
1170 x 1955	1320 x 2041	4066	1159	1159	1159	1265	981	1159	1159
1170 x 2110	1320 x 2196	4070	1171	1171	1171	1275	1004	1171	1171

¹ No fitting clearance allowed.

² Windows for Beaumont: Standard () , Diamond () , Cross () . Please state on order if plain or crystal panes.

³ Doors under 1000 mm width only have one vertical column of pressings. These doors vary from images shown.

Steel door - purpose-made sizes

Nominal Door Size Width x Height (mm x mm)	Overall frame size (between fix) ¹ Width x Height (mm x mm)					
		Georgian	Beaumont	Cathedral	Beaumont with Windows ²	Carlton
670-1036 x 1905-2110	820-1186 x 1991-2196	1287 ⁴	1287 ⁴	1287 ⁴	1434 ⁴	1127
1037-1310 x 1905-2110	1187-1320 x 1991-2196	1359	1359	1359	1505	1195



¹ No fitting clearance allowed.

² Windows for Beaumont: Standard , Diamond , Cross . Please state on order if plain or crystal panes.

⁴ Cathedral, Beaumont and Georgian are available at a minimum overall frame size of 882 mm.



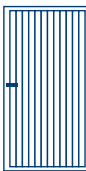
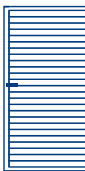
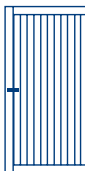

All doors come factory pre-framed, right hand hinged with the handle on the left as standard (viewed from outside). Supplied with lever/lever handle set. Doors only available to open outwards.

Timber door - standard sizes

Nominal Door Size Width x Height (mm x mm)	Overall frame size (between fix) ¹ Width x Height (mm x mm)	Size Code				
			Vertical Timber	Horizontal Timber	Kingsbury	Seymour
732 x 1905	882 x 1991	2664	2505	2565	2723	2505
732 x 1955	882 x 2041	2666	2538	2596	2749	2538
732 x 2110	882 x 2196	2670	2582	2635	2789	2582
884 x 1905	1034 x 1991	3064	2596	2650	2802	2596
884 x 1955	1034 x 2041	3066	2622	2677	2833	2622
884 x 2110	1034 x 2196	3070	2664	2723	2871	2664
1037 x 1905	1187 x 1991	3664	2677	2733	2893	2677
1037 x 1955	1187 x 2041	3666	2705	2764	2916	2705
1037 x 2110	1187 x 2196	3670	2749	2802	2958	2749
1170 x 1905	1320 x 1991	4064	2764	2816	2970	2764
1170 x 1955	1320 x 2041	4066	2789	2848	3002	2789
1170 x 2110	1320 x 2196	4070	2833	2893	3037	2833

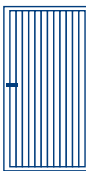
¹ No fitting clearance allowed.

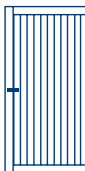
Timber door - purpose-made sizes

Nominal Door Size Width x Height (mm x mm)	Overall frame size (between fix) ¹ Width x Height (mm x mm)				
		Vertical Timber	Horizontal Timber	Kingsbury ²	Seymour
670-1036 x 1905-2110	820-1186 x 1991-2196	3027	3085	3237	3027
1037-1310 x 1905-2110	1187-1320 x 1991-2196	3195	3251	3400	3195

¹ No fitting clearance allowed.

² Minimum overall frame width for Kingsbury is 826 mm.

Steel, Timber and GRP Side-hinged Doors

Surface

Steel Side-hinged doors are constructed around a strong steel box section chassis in Traffic White (RAL 9016) as standard. Timber doors constructed using timber, built around our steel box section chassis. A range of stain options are available. All Garador timber side-hinged garage doors are plywood backed, the timber boards are not visible from the inside of the garage door.

Pre-Framed Design and Concealed Hinges

All doors come factory pre-framed with 75mm wide door frame and right-hand door leaf leading as standard. Hinges are concealed in the frame, with no hinge knuckles protruding above the surface of the door.

Two-Point Locking

A shoot bolt latch is used to secure the fixed door leaf at the top and bottom.

Door Stays and Gas Pistons

Supplied complete with solid metal door stays and pull cord release. Gas pistons are fitted to each door leaf for a controlled closing motion.

Rubber weather seals

Sturdy rubber weather seals all built into the door frame and along the door stop on the fixed and leading door leaf.

Aluminium threshold

A 20 mm aluminium threshold is supplied as standard at the base of the door.

Steel Colours

Standard colours are:

- Traffic White (RAL 9016)

Optional colours available on an approximate 4 week lead-time:

- | | | | |
|--------------------------|------------------------------|--------------------------|-----------------------------|
| - Light Ivory (RAL 1015) | - Pigeon Blue (RAL 5014) | - Slate Grey (RAL 7015) | - Burgundy Brown |
| - Ruby Red (RAL 3003) | - Moss Green (RAL 6005) | - Terra Brown (RAL 8028) | - Golden Brown |
| - Signal Blue (RAL 5005) | - Fir Green (RAL 6009) | - Jet Black (RAL 9005) | - Chartwell Green (BS 4800) |
| - Steel Blue (RAL 5011) | - Anthracite Grey (RAL 7016) | | |

Other optional colours available on an approximate 6 week lead-time:

- | | | | |
|-------------------------|-------------------------|--------------------------|-------------------------|
| - Stone Grey (RAL 7030) | - Light grey (RAL 7035) | - Window Grey (RAL 7040) | - Agate Grey (RAL 7038) |
|-------------------------|-------------------------|--------------------------|-------------------------|

Timber Stains

Full finished stains available as an option. Stain colours include Light Oak, Antique Oak, Mahogany, Walnut, Chestnut and Ebony

GRP Colours

White, Magnolia, Bleached Oak, Red Mahogany, Dark Mahogany, Light Oak, Dark Oak, Irish Oak, Honey Beech, Teak, Rosewood, Golden Brown, Ebony, Anthracite Grey, Green, Blue, Gloss White and Gloss Magnolia.

Handle

Supplied with black lever/ lever handle on right side (viewed outside) and centrally located flip-up handle which releases shoot-bolt latches at the top and bottom of the fixed leaf (viewed inside).

Terminology

Nominal Door Size: This is the actual door panel size plus the fitting tolerances. The nominal door size should be used for internal dimensions of a timber frame.

Size Code: This has traditionally been used to order doors. This may not be the actual door size.

Packaging

All doors are supplied unwrapped as standard, with optional poly-wrapping available.

Steel door - standard sizes

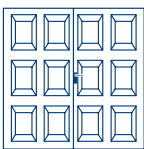
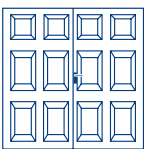
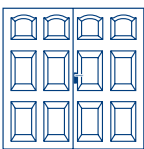
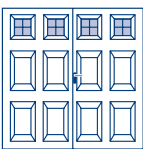
Nominal Door Size Width x Height (mm x mm)	Overall frame size (between fix) ¹ Width x Height (mm x mm)	Size Code				
			Georgian	Beaumont	Cathedral	Beaumont with Windows ²
1780 x 1806	1930 x 1891	6060	-	-	-	-
1934 x 1806	2084 x 1891	6660	-	-	-	-
1934 x 1907	2084 x 1991	6664	-	-	-	-
1934 x 1957	2084 x 2041	6666	-	-	-	-
1934 x 2112	2084 x 2196	6670	-	-	-	-
2084 x 1806	2234 x 1891	7060	-	-	-	-
2084 x 1907	2234 x 1991	7064	2034	2034	2034	2430
2084 x 1957	2234 x 2041	7066	2034	2034	2034	2430
2084 x 2112	2234 x 2196	7070	2065	2065	2065	2462
2209 x 1907	2359 x 1991	7564	2128	2128	2128	2526
2209 x 1957	2359 x 2041	7566	2128	2128	2128	2526
2209 x 2112	2359 x 2196	7570	2162	2162	2162	2558
2234 x 1907	2384 x 1991	7664	2162	2162	2162	2558
2234 x 1957	2384 x 2041	7666	2162	2162	2162	2558
2234 x 2112	2384 x 2196	7670	2190	2190	2190	2587
2389 x 1907	2539 x 1991	8064	2256	2256	2256	2652
2389 x 1957	2539 x 2041	8066	2256	2256	2256	2652
2389 x 2112	2539 x 2196	8070	2284	2284	2284	2681

Steel door - standard sizes

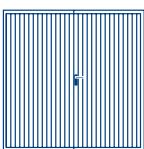
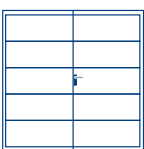
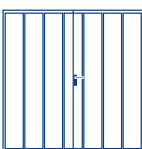
Nominal Door Size Width x Height (mm x mm)	Overall frame size (between fix) ¹ Width x Height (mm x mm)	Size Code			
			Carlton	Ascot	Windsor
1780 x 1806	1930 x 1891	6060	1788	-	-
1934 x 1806	2084 x 1891	6660	1817	-	-
1934 x 1907	2084 x 1991	6664	1848	-	-
1934 x 1957	2084 x 2041	6666	1848	-	-
1934 x 2112	2084 x 2196	6670	1883	-	-
2084 x 1806	2234 x 1891	7060	1883	-	-
2084 x 1907	2234 x 1991	7064	1913	2034	2034
2084 x 1957	2234 x 2041	7066	1913 ³	2034	2034
2084 x 2112	2234 x 2196	7070	1944 ³	2065	2065
2209 x 1907	2359 x 1991	7564	2007	2128	2128
2209 x 1957	2359 x 2041	7566	2007	2128	2128
2209 x 2112	2359 x 2196	7570	2034	2162	2162
2234 x 1907	2384 x 1991	7664	2034	2162	2162
2234 x 1957	2384 x 2041	7666	2034	2162	2162
2234 x 2112	2384 x 2196	7670	2065	2190	2190
2389 x 1907	2539 x 1991	8064	2128	2256	2256
2389 x 1957	2539 x 2041	8066	2128	2256	2256
2389 x 2112	2539 x 2196	8070	2162	2284	2284

¹ No fitting clearance allowed.

² Windows for Beaumont: Standard , Diamond , Cross . Please state on order if plain or crystal panes.

³ Carlton 7070 stock door: only available as Traffic White (RAL 9016) with right-hand leading.

All doors come factory pre-framed, right hand door leaf leading as standard (viewed from the outside) with lever/lever handle set.

Ascot and Windsor side-hinged garage doors are only available in 50/ 50 door leaf configuration.

The above doors are shown as 50/50 door leaves configuration. Up to 2234 mm overall frame width these doors are also available as a 1/3 2/3 door configuration. Prices are the same but please be aware panel configurations on Georgian, Beaumont & Cathedral doors will have 3 pressing columns with increased spacing between the pressing (1/3 2/3 is a term used to describe these doors but please note the 1/3 door leaf is always 800 mm wide with the 2/3 element varying to make the desired overall width). 1/3 leaf is always leading.

Steel door - purpose-made sizes

Overall frame size
(between fix)¹
Width x Height
(mm x mm)

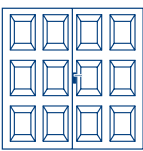
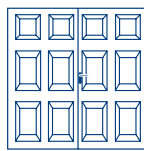
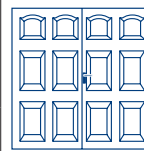
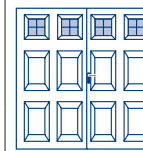
	 Georgian	 Beaumont	 Cathedral	 Beaumont with Windows ²
1930 - 2234 x 1891 - 2041	-	-	-	-
1930 - 2234 x 2042 - 2196	-	-	-	-
2235 - 2384 x 1891 - 1990	-	-	-	-
2235 - 2384 x 1991 - 2041	2268	2268	2268	2759
2235 - 2384 x 2042 - 2196	2291	2291	2291	2781
2385 - 2539 x 1891 - 1990	-	-	-	-
2385 - 2539 x 1991 - 2041	2394	2394	2394	2880
2385 - 2539 x 2042 - 2196	2420	2420	2420	2910

Steel door - purpose-made sizes

Overall frame size
(between fix)¹
Width x Height
(mm x mm)

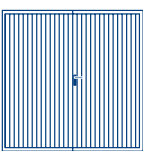
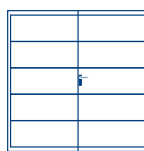
	 Carlton	 Ascot
1930 - 2234 x 1891 - 2041	2023	-
1930 - 2234 x 2042 - 2196	2075	-
2235 - 2384 x 1891 - 1990	2099	-
2235 - 2384 x 1991 - 2041	2162	2268
2235 - 2384 x 2042 - 2196	2202	2291
2385 - 2539 x 1891 - 1990	2184	-
2385 - 2539 x 1991 - 2041	2266	2394
2385 - 2539 x 2042 - 2196	2293	2420

¹ No fitting clearance allowed.

² Windows for Beaumont: Standard () , Diamond () , Cross () . Please state on order if plain or crystal panes.

All doors come factory pre-framed, right hand door leaf leading as standard (viewed from the outside) with lever/lever handle set.



Ascot and Windsor side-hinged garage doors are only available in 50/ 50 door leaf configuration.

The above doors are shown as 50/50 door leaves configuration. Up to 2234 mm overall frame width these doors are also available as a 1/3 2/3 door configuration. Prices are the same but please be aware panel configurations on Georgian, Beaumont & Cathedral doors will have 3 pressing columns with increased spacing between the pressing (1/3 2/3 is a term used to describe these doors but please note the 1/3 door leaf is always 800 mm wide with the 2/3 element varying to make the desired overall width). 1/3 leaf is always leading.

Timber door - standard sizes

Nominal Door Size Width x Height (mm x mm)	Overall frame size (between fix) ¹ Width x Height (mm x mm)	Size Code					
			Vertical Timber ²	Horizontal Timber ²	Kingsbury ³	Seymour ³	Tudor ³
1780 x 1806	1930 x 1891	6060	4110	4191	4582	3900	3900
1934 x 1806	2084 x 1891	6660	4161	4248	4582	3952	3952
1934 x 1907	2084 x 1991	6664	4161	4248	4582	3952	3952
1934 x 1957	2084 x 2041	6666	4200	4287	4595	3992	3992
1934 x 2112	2084 x 2196	6670	4200	4287	4649	3992	3992
2084 x 1806	2234 x 1891	7060	4268	4352	4649	4058	4058
2084 x 1907	2234 x 1991	7064	4281	4366	4681	4071	4071
2084 x 1957	2234 x 2041	7066	4296	4378	4736	4082	4082
2084 x 2112	2234 x 2196	7070	4296	4378	4763	4082	4082
2209 x 1907	2359 x 1991	7564	4331	4420	4907	4128	4128
2209 x 1957	2359 x 2041	7566	4343	4434	4936	4138	4138
2209 x 2112	2359 x 2196	7570	4371	4453	5025	4161	4161
2234 x 1907	2384 x 1991	7664	4331	4420	4922	4128	4128
2234 x 1957	2384 x 2041	7666	4343	4434	4983	4138	4138
2234 x 2112	2384 x 2196	7670	4371	4454	5080	4161	4161
2389 x 1907	2539 x 1991	8064	4502	4588	5366	4296	4296
2389 x 1957	2539 x 2041	8066	4513	4601	5392	4308	4308
2389 x 2112	2539 x 2196	8070	4531	4610	5535	4318	4318

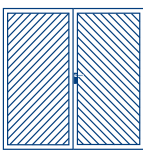
Timber door - standard sizes

Nominal Door Size Width x Height (mm x mm)	Overall frame size (between fix) ¹ Width x Height (mm x mm)	Size Code			
			Chevron Timber ³	Ashton ^{3,4}	Ashton Chevron ^{3,4}
1780 x 1806	1930 x 1891	6060	4582	4922	5142
1934 x 1806	2084 x 1891	6660	4582	4922	5142
1934 x 1907	2084 x 1991	6664	4582	4922	5142
1934 x 1957	2084 x 2041	6666	4595	4936	5152
1934 x 2112	2084 x 2196	6670	4649	4983	5208
2084 x 1806	2234 x 1891	7060	4649	4983	5208
2084 x 1907	2234 x 1991	7064	4681	5025	5247
2084 x 1957	2234 x 2041	7066	4736	5080	5298
2084 x 2112	2234 x 2196	7070	4763	5101	5326
2209 x 1907	2359 x 1991	7564	4907	5247	5467
2209 x 1957	2359 x 2041	7566	4936	5271	5497
2209 x 2112	2359 x 2196	7570	5025	5366	5588
2234 x 1907	2384 x 1991	7664	4922	5258	5483
2234 x 1957	2384 x 2041	7666	4983	5326	5546
2234 x 2112	2384 x 2196	7670	5080	5413	5642
2389 x 1907	2539 x 1991	8064	5366	5703	5928
2389 x 1957	2539 x 2041	8066	5392	5283	5956
2389 x 2112	2539 x 2196	8070	5535	5874	6095

¹ No fitting clearance allowed.

² The above doors are shown as 50/50 door leaves configuration. Up to 2234 mm overall frame width these doors are also available as a 1/3 2/3 door configuration on Vertical Timber and Horizontal Timber doors.

Prices are the same but please be aware panel configurations may be different from those shown above (1/3 2/3 is a term used to describe these doors but please note the 1/3 door leaf is always 800 mm wide with the 2/3 element varying to make the desired overall width). 1/3 leaf is always leading.

³ Not available in 70/30 configuration. Only Vertical Timber and Horizontal Timber Side Hinged doors are available in 70/30 configuration up to 7'0" wide.

⁴ On doors with windows, please state on order if plain or crystal panes.

Timber door - purpose-made sizes

Overall frame size
(between fix)¹
Width x Height
(mm x mm)

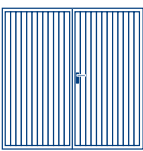
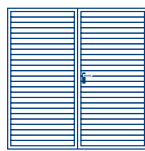
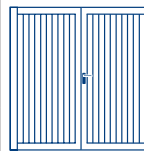
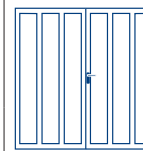
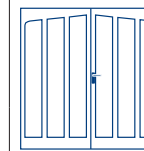

	 Vertical Timber ²	 Horizontal Timber ²	 Kingsbury ³	 Seymour ³	 Tudor ³
1930 - 2234 x 1891 - 2041	4369	4454	4816	4176	4176
1930 - 2234 x 2042 - 2196	4454	5309	4906	4263	4263
2235 - 2384 x 1891 - 2041	4539	5424	4997	4353	4353
2235 - 2384 x 2042 - 2196	4661	4748	5341	4471	4471
2385 - 2539 x 1891 - 2041	4906	4997	5596	4715	4715
2385 - 2539 x 2042 - 2196	4981	5075	5687	4788	4788

¹ No fitting clearance allowed.

² On doors with windows, please state on order if plain or crystal panes.

Timber door - purpose-made sizes

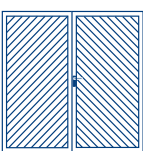
Overall frame size
(between fix)¹
Width x Height
(mm x mm)

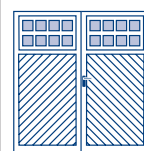
	 Chevron Timber ³	 Ashton ^{3,4}	 Ashton Chevron ^{3,4}
1930 - 2234 x 1891 - 2041	4816	5148	5367
1930 - 2234 x 2042 - 2196	4906	5242	5457
2235 - 2384 x 1891 - 2041	4997	5328	5546
2235 - 2384 x 2042 - 2196	5341	5693	6948
2385 - 2539 x 1891 - 2041	5596	5949	6178
2385 - 2539 x 2042 - 2196	5687	6028	6260

¹ No fitting clearance allowed.



² The above doors are shown as 50/50 door leaves configuration. Up to 2234 mm overall frame width these doors are also available as a 1/3 2/3 door configuration on Vertical Timber and Horizontal Timber doors.

Prices are the same but please be aware panel configurations may be different from those shown above (1/3 2/3 is a term used to describe these doors but please note the 1/3 door leaf is always 800 mm wide with the 2/3 element varying to make the desired overall width). 1/3 leaf is always leading.

³ Not available in 70/30 configuration. Only Vertical Timber and Horizontal Timber Side Hinged doors are available in 70/30 configuration up to 7'0" wide.

⁴ On doors with windows, please state on order if plain or crystal panes.

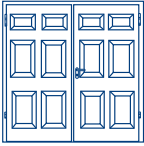
GRP door - standard sizes

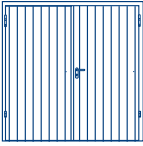
Nominal Door Size (between fix) ¹ Width x Height (mm x mm)	Overall frame size (between fix) ¹ Width x Height (mm x mm)	Size Code				
			Dorchester ²	Kenmore	Arden	Somerset ³
1780 x 1806	1930 x 1891	6060	-	-	-	3571
1934 x 1806	2084 x 1891	6660	-	-	-	3571
1934 x 1907	2084 x 1991	6664	-	-	-	3571
1934 x 1957	2084 x 2041	6666	-	-	-	3571
1934 x 2112	2084 x 2196	6670	-	-	-	3571
2084 x 1806	2234 x 1891	7060	-	-	-	3616
2084 x 1907	2234 x 1991	7064	-	-	-	3616
2084 x 1957	2234 x 2041	7066	-	-	-	3665
2084 x 2112	2234 x 2196	7070	-	-	-	3665
2209 x 1907	2359 x 1991	7564	3780	3780	3780	3780
2209 x 1957	2359 x 2041	7566	3780	3780	3780	3780
2209 x 2112	2359 x 2196	7570	3780	3780	3780	3780
2234 x 1907	2384 x 1991	7664	3780	3780	3780	3780
2234 x 1957	2384 x 2041	7666	3780	3780	3780	3780
2234 x 2112	2384 x 2196	7670	3780	3780	3780	3780
2389 x 1907	2539 x 1991	8064	3898	3898	3898	3898
2389 x 1957	2539 x 2041	8066	3898	3898	3898	3898
2389 x 2112	2539 x 2196	8070	3898	3898	3898	3898

GRP door - purpose-made sizes

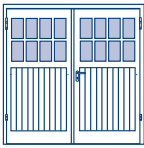
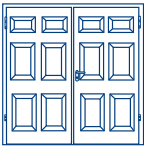
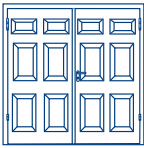
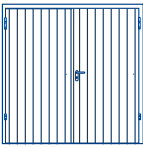
Overall frame size (between fix) ¹ Width x Height (mm x mm)				
	Dorchester ²	Kenmore	Arden	Somerset ³
1930 - 2234 x 1891 - 2041	-	-	-	4207
1930 - 2234 x 2042 - 2196	-	-	-	4286
2235 - 2384 x 1891 - 2041	-	-	-	4365
2235 - 2384 x 2042 - 2196	-	-	-	4445
2385 - 2539 x 1891 - 2041 ¹	4524	4524	4524	4524
2385 - 2539 x 2042 - 2196	4597	4597	4597	4597

¹ Please note Dorchester, Kenmore and Arden side-hinged garage doors have a minimum overall frame size of 2359 mm x 1980 mm.

² For Dorchester side-hinged garage doors, only clear glazing or stippled glazing available for windows.

³ The Somerset GRP side-hinged garage door is also available in a 70/30 configuration. All other GRP side-hinged garage doors are only available in 50/50 configuration.

Options	Steel		Timber		GRP	
	Garage side doors	Side-hinged doors	Garage side doors	Side-hinged doors	Garage side doors	Side-hinged doors
	add	add	add	add	add	add
For powder-coated steel doors ¹ : - Moss Green (RAL 6005) - Ruby Red (RAL 3003) - Signal Blue (RAL 5005) - Jet Black (RAL 9005) - Steel Blue (RAL 5011) - Light Ivory (RAL 1015) - Pigeon Blue (RAL 5014) - Fir Green (RAL 6009) - Anthracite Grey (RAL 7016) - Stone Grey (RAL 7030) - Light Grey (RAL 7035) - Slate Grey (RAL 7015) - Agate Grey (RAL 7038) - Window Grey (RAL 7040) - Chartwell Green (BS 4800) - Burgundy Brown - Golden Oak (solid) - Terra Brown (RAL 8028)	127	166	-	-	-	-
Coloured window frames to match door colour – Beaumont doors (price per window). Beaumont doors up to 2539 mm wide = 4 windows ² .	61 each	61 each	-	-	-	-
Surcharge for Premium GRP colours: - Green - Blue	-	-	-	-	-	765
Handles for steel and timber doors: - knob/lever black plastic	42	42	42	42	42	42
For timber doors: factory fully finished in - Light Oak - Antique Oak - Mahogany - Walnut - Chestnut - Ebony	-	-	177	269	-	-
Factory white primer ready for on-site painting	-	-	269	330	-	-
Factory fully finished painting (any RAL colour)	-	-	444	552	-	-
Anodised Aluminium lever/lever handles: - white	156	156	156	156	-	156
Anodised Aluminium lever/lever handles: - chrome effect	195	195	195	195	-	195
Left hand leading	114	114	114	114	-	114
Fitting compensation kit (part no. 8261)	173	173	173	173	173	173
Poly-wrapping	44	44	44	44	44	44

¹ Coloured Beaumont with windows doors are supplied with white or brown window frames as standard.

² Colour match windows not available in Burgundy Brown or Golden Brown.

For timber side-hinged doors chassis is either Traffic White (RAL 9016) or Terra Brown (RAL 8028) regardless of exact colour of timber finishing, except when Ebony finishing is ordered and then the chassis will be supplied in black.

Garage Side Doors & Side-hinged Doors – Specifications

Door leaves supplied factory pre-framed ready for site installation. Fixed leaf (RH side when viewed from inside) fitted with tower bolts at top and bottom of inner leading edge. The floor will need to be finished and level for the bottom tower bolts to engage. These doors are designed for in-between fixing.

Garage Side door factory pre-framed

Between brickwork fixing

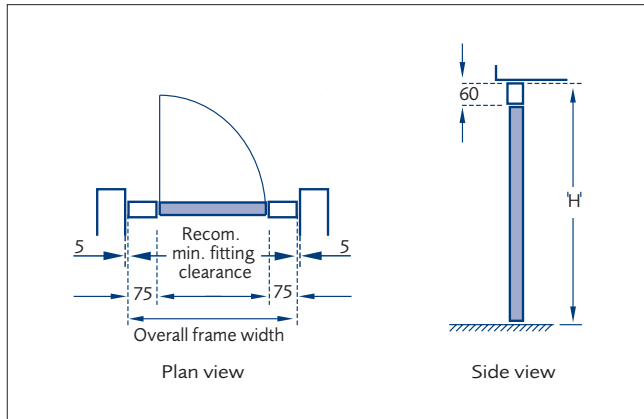

Door specification

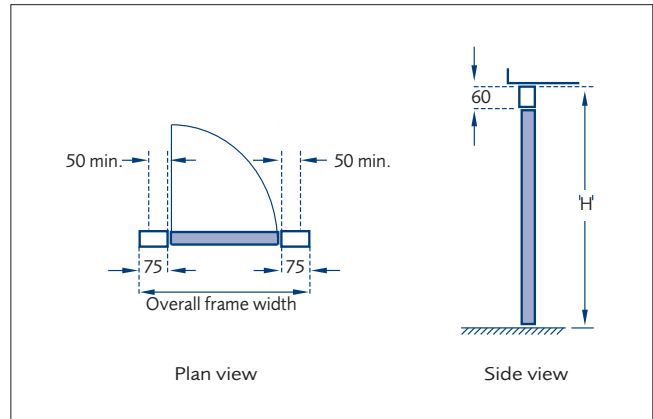

The nominal clear passage clearance is 74 mm less than the opening width and 125 mm less than the opening height. **Not recommended** for behind brickwork fixing.

Side-hinged door factory pre-framed

Between brickwork fixing

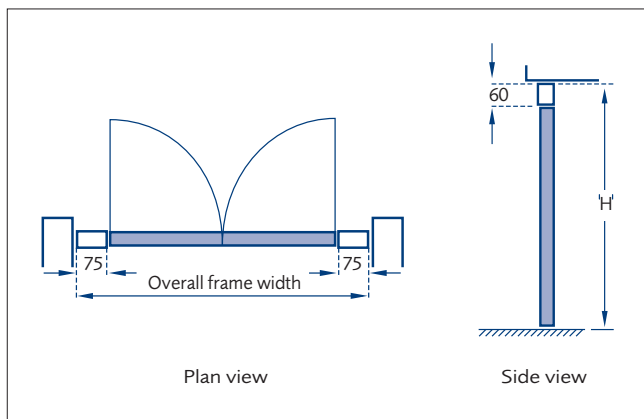

Door specification

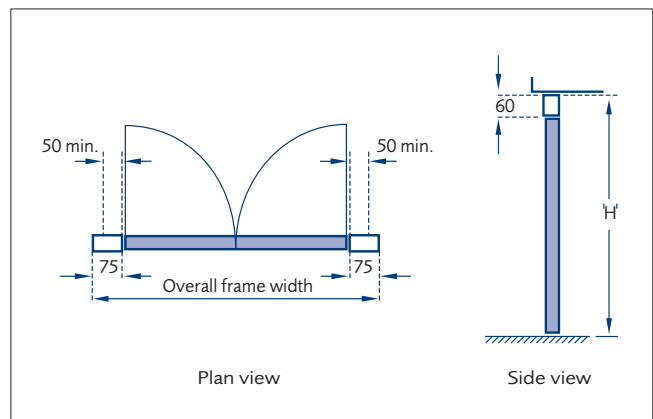

The nominal drive through clearance is 30 mm less than the opening width and 125 mm less than the opening height. **Not recommended** for behind brickwork fixing.

Side-Hinged Garage Door Steel Frame Specifications

	Width	Height	Depth
Side-Hinged Doors	75 mm	60 mm	75 mm

Steel Panel Doors – Specifications

Canopy Gear Specifications

The canopy gear allows the door to travel in vertical tracks and is counterbalanced by an overhead torsion spring. The nominal drive through is 40 mm less than the opening width and 130 mm less than the opening height.

In the open position, the door projects approximately one third of the door height, forming a canopy.

For doors fitted with an operator, please observe operator specifications.

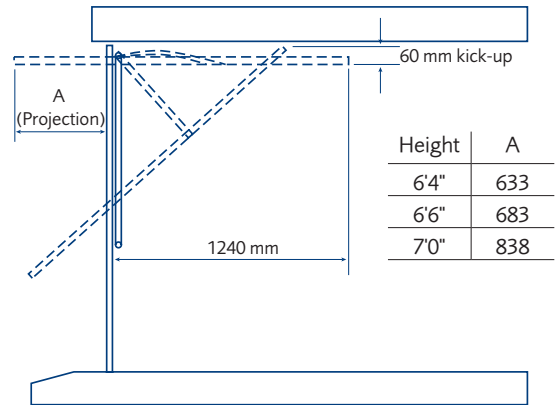

On-site timber frame

Behind brickwork fixing

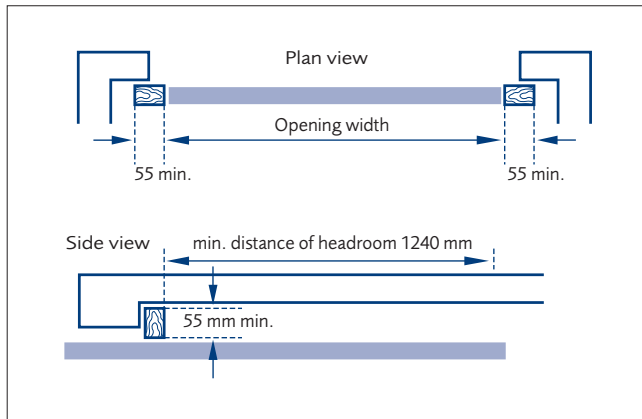

Between brickwork fixing

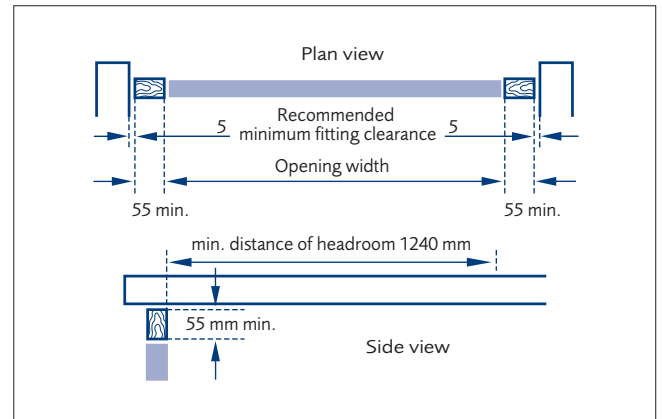

Factory pre-framed with steel box frame

The garage door is supplied factory fitted to a steel box section frame and is secured to the brickwork by using just 7 fixings.

Behind brickwork fixing

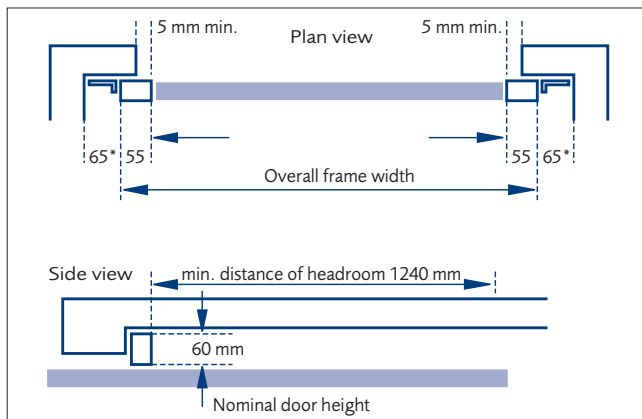

* width of anchor brackets in this position

Between brickwork fixing

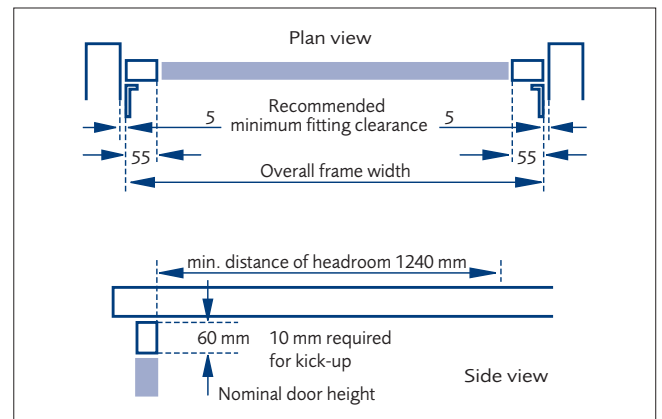

Up & Over Garage Door Steel Frame Dimensions

	Width	Depth
Canopy steel frame (single door)	60 mm	40 mm
Retractable steel frame (single door)	75 mm	40 mm
Retractable steel frame (double door)	75 mm	80 mm

Single & Double Retractable Gear Specifications

The retractable gear allows the door to be retracted inside the garage when open by means of horizontal overhead tracks supported by wall or ceiling mounted suspension brackets. This gear is available as an option for single doors and comes as standard with double garage doors.

The nominal drive through clearance is 105 mm less than the opening width and 110 mm less than the opening height for single doors and 140 mm less than the opening height for double doors.

For doors fitted with an operator, please observe operator specifications.

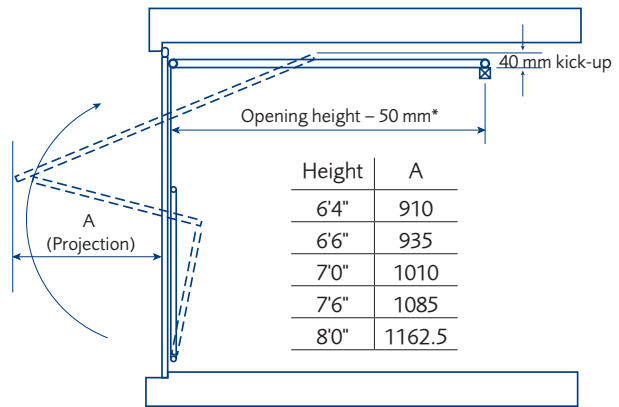

* Only applies to single doors up to 1070.

On-site timber frame

Behind brickwork fixing

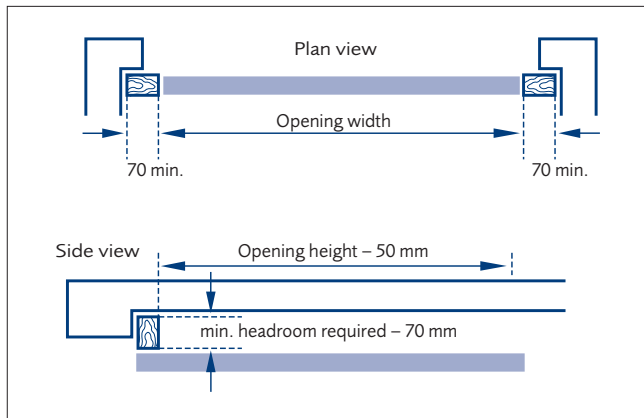

Between brickwork fixing

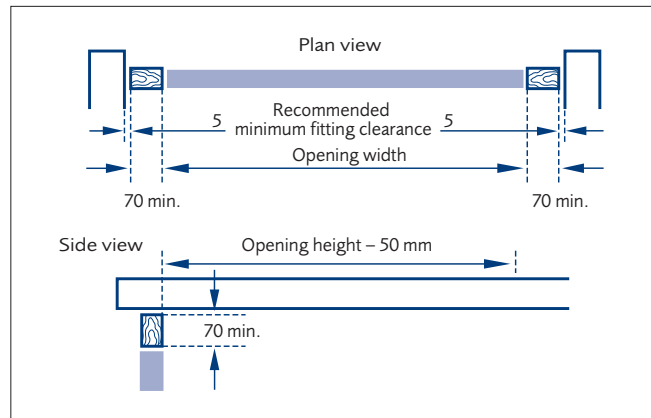

Factory pre-framed with steel box frame

The garage door is supplied factory fitted to a steel box section frame and is secured to the brickwork by using just 7 fixings.

Behind brickwork fixing

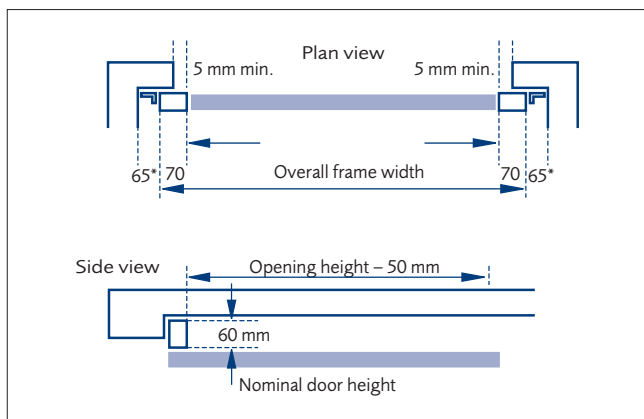

Between brickwork fixing

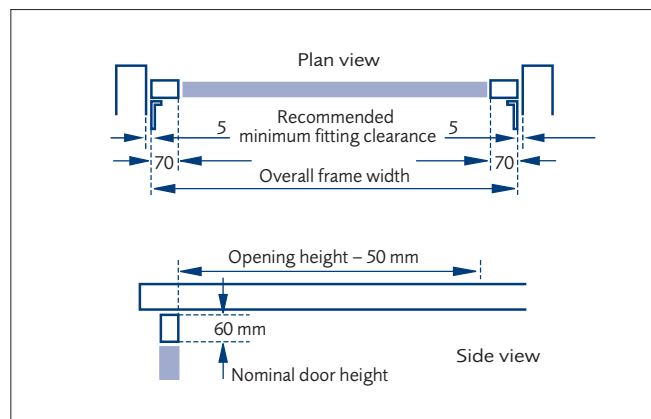

* width of anchor brackets in this position

Retractable Plus Gear

For any door up to a width of 2744 mm in any of the three standard heights Retractable Plus Gear is available. This gear type creates clear drive through width at the crucial wing mirror height.

Door height	Clear height below lifting arms
7'0"	1260
6'6"	1105
6'4"	1055

Steel Sectional Garage Doors

Door sections

Made of galvanised steel. Premium doors have a 42 mm thick insulated door section that is filled with PU-foam (100 % CFC-free). Bottom door section comes with floor seal.

Surface

Outside: Woodgrain embossed, Slategrain, Sandgrain or Silkgrain textures with painted or foil coated finishes.
 Inside: pebble texture.

Spring arrangement

All doors up to 4000 mm wide (excluding Silkgrain) come with tension springs as standard and torsion springs are available at extra cost. All doors over 4000 mm wide (excluding Silkgrain) come with torsion springs as standard. Low headroom application available at extra cost. Doors with a Silkgrain surface finish are supplied with tension springs as standard up to 3049 mm wide and torsion springs as standard on doors over 3050 mm wide.

Side frames & Fascia

Sectional doors are designed to be fitted behind the reveals and side frames are supplied white in colour. Cover profiles are available for use with coloured or foil coated door finishes. A single skin fascia is supplied with all doors which is finished in the same colour as the door sections. For Slategrain models, the door section has a Slategrain texture but the cover profiles and fascia are smooth.

Colours

Steel Woodgrain and Silkgrain doors can be ordered in almost any colour from the RAL colour chart. Slategrain is only available in standard RAL colours and Traffic White (RAL 9016).

Standard colours are:

- | | | | |
|--------------------------|------------------------------|--------------------------|------------------------------|
| - Light Ivory (RAL 1015) | - Slate Grey (RAL 7015) | - Light Grey (RAL 7035) | - Jet Black (RAL 9005) |
| - Moss Green (RAL 6005) | - Anthracite Grey (RAL 7016) | - Quartz Grey (RAL 7039) | - White Aluminium (RAL 9006) |
| - Fir Green (RAL 6009) | - Titan Metallic (CH 703) | - Window Grey (RAL 7040) | - Grey Aluminium (RAL 9007) |
| - Basalt Grey (RAL 7012) | - Stone Grey (RAL 7030) | - Terra Brown (RAL 8028) | |

Special RAL colours are:

- | | | | |
|-------------------------|--------------------------|-----------------------------|-----------------------------|
| - Black Red (RAL 3007) | - Black Grey (RAL 7021) | - Signal Black (RAL 9004) | - Traffic Black (RAL 9017) |
| - Black Blue (RAL 5004) | - Black Brown (RAL 8022) | - Graphite Black (RAL 9011) | - Chartwell Green (BS 4800) |

Non standard RAL colours are:

Based on full RAL colour chart excluding Traffic Purple (RAL 4006), Purple Violet (RAL 4007) and pearlescent or florescent options.

Timber effect foil coated doors are available in the following five finishes:

Golden Oak, Dark Oak, Night Oak, Rosewood and Winchester Oak. Only Golden Oak and Rosewood surface finishes are kept as stock door sizes (prices highlighted in bold) for timber effect sectional garage doors. Dark Oak, Night Oak and Winchester Oak surface finishes are not stocked, but are made to order.

Foil coated finish also available in Titan Metallic (CH 703)

Handle

Sectional doors in shaded boxes are generally supplied ex-works for automatic operation, i.e. without handle hole and lock. Factory-fitted handle and lock are available with an increased lead-time. All other doors are on a 4 to 6 week lead-time. For electrical operation of a garage with no other personal access, an emergency release kit must be fitted.

Packaging

Sectional doors are provided in a palletted format shrink wrapped for easy handling.

Stock availability

Popular sectional doors are generally ex-stock in Traffic White (RAL 9016) and Terra Brown (RAL 8028) in some sizes, other sizes and colour options require up to 6 weeks lead-time. Contact sales office for further details.

Gears

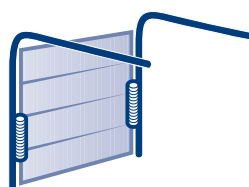

Tension spring

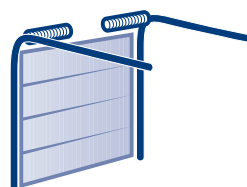

Torsion spring

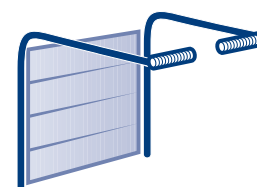

Low headroom
torsion spring fitting

Window options

Georgian design

Prices £ stated per window
Window frames white as standard

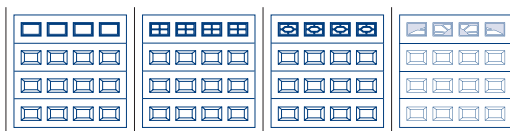

	Standard	Cross	Diamond	Sunrise
Premium - Woodgrain ¹	139	173	173	178
Premium - Timber effect ²	178	211	211	219

Linear small design

Prices £ stated per window
Window frames white as standard

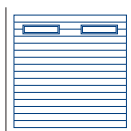

	Linear 1
Premium - Woodgrain ¹	139

Linear medium design

Prices £ stated per window
Window frames white as standard



	Standard	Cross	Diamond	Sunrise	Linear 1	Linear 2
Premium - Woodgrain Sandgrain, Silkgrain ¹ , Slategrain	139	173	173	178	139	171
Premium - Timber effect ²	178	211	211	219	178	209

Linear large design

Prices £ stated per window
Window frames white as standard



	Standard	Cross	Diamond	Sunrise	Linear 1	Linear 2	Linear 3
Premium - Sandgrain, Silkgrain, Slategrain	139	173	173	178	139	171	221
Premium - Timber effect ²	178	211	211	219	178	209	259

¹ Colours available at surcharge per window (£ 42 for standard colour, £ 69 for non standard colour, £ 132 for special RAL colour).

² Window frames are painted in a colour to best complement the colour of the foil coat (colour incl. in price).

Please note, window frames are painted in a colour to complement the colour of the sectional garage door.

Standard, Cross, Diamond and Sunrise (overall frame dimension: 395 mm x 270 mm)

Doors up to 2124 mm wide have 3 windows, 2125 mm to 2749 mm wide have 4 windows, 2750 mm to 3499 mm wide have 5 windows, 3500 mm to 3999 mm wide have 6 windows, 4000 mm to 4749 mm wide have 7 windows and doors of 4750 mm up to 5500 mm wide have 8 windows. Sunrise windows only available from 2130 mm wide doors up to 5500 mm wide doors.

Linear 1 (overall frame dimension: 680 mm x 210 mm)

Doors up to 2499 mm wide have 2 windows, 2500 mm to 3499 mm wide have 3 windows, 3500 mm to 4499 mm wide have 4 windows and doors over 4500 mm wide have 5 windows.

Linear 2 (overall frame dimension: 620 mm x 270 mm)

Doors up to 2239 mm wide have 2 windows, 2240 mm to 2969 mm wide have 3 windows, 2970 mm to 3689 mm wide have 4 windows, 3690 mm to 4419 mm wide have 5 windows and doors over 4420 mm have 6 windows.

Linear 3 (overall frame dimension: 1004 mm x 270 mm)

Door widths from 2250 mm to 3399 mm have 2 windows, 3400 mm to 4489 mm have 3 windows, 4490 mm to 5499 mm have 4 windows, 5500 mm to 6000 mm have 6 windows.

Please state on order if clear or crystal panes. Georgian sectional doors under 7 ft wide only have 3 pressings.

Secured by Design – Free optional upgrade available after installation

The following criteria must be met to be eligible for Secured by Design accreditation:

- Premium 42 mm sectional door (without windows).
- Fitted behind the opening.
- Automated with a GaraMatic operator (sold separately).
- Door must be fitted to SBD standard, unmodified and registered with Garador.



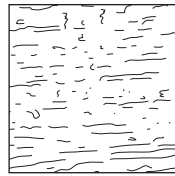
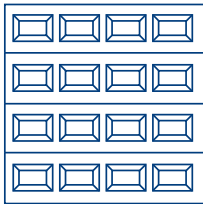

Woodgrain

Georgian design

Brickwork opening Width x Height (mm x mm)	Size Code	 Premium	Surcharge for Standard Colours	Surcharge for Non-Std. Colours	Surcharge for Special RAL
2080 x 2000	I 61066	1703	229	376	733
2080 x 2080	I 610610	1722	239	391	762
2134 x 2000	I 7066	1761	236	385	751
2134 x 2125	I 7070	1783	251	409	799
2250 x 1875	M 7462	1810	233	381	742
2250 x 2000	M 7466	1862	249	406	792
2250 x 2125	M 7470	1865	264	431	842
2286 x 2000	I 7666	1761	253	413	805
2286 x 2125	I 7670	1783	269	438	855
2286 x 2250	I 7674	1778	284	464	906
2286 x 2375	I 7679	1900	299	489	956
2286 x 2500	I 7682	1896	315	516	1006
2375 x 1875	M 7962	1810	246	402	784
2375 x 2000	M 7966	1812	262	429	837
2375 x 2125	M 7970	1817	278	455	889
2375 x 2250	M 7974	1895	295	482	941
2438 x 2000	I 8066	1858	270	439	858
2438 x 2125	I 8070	1887	286	467	912
2438 x 2250	I 8074	1875	303	494	966
2438 x 2375	I 8079	1999	320	522	1019
2438 x 2500	I 8082	1994	337	550	1073
2500 x 1875	M 8262	1810	259	422	825
2500 x 2000	M 8266	1812	276	451	880
2500 x 2125	M 8270	1817	293	480	935
2500 x 2250	M 8274	1895	311	507	991
2500 x 2375	M 8279	1987	328	536	1046
2500 x 2500	M 8282	1992	345	563	1101
2500 x 2750	M 8290	2157	380	620	1210
2591 x 2000	I 8666	1858	286	467	912
2591 x 2125	I 8670	1887	304	497	969
2625 x 2125	M 8770	1967	308	503	982
2740 x 2000	I 9066	2024	303	494	965
2740 x 2125	I 9070	2052	322	525	1026
2750 x 2000	M 9166	2195	304	497	968
2750 x 2125	M 9170	2236	323	527	1029
2750 x 2250	M 9174	2319	342	558	1089
2750 x 2375	M 9179	2338	361	589	1150
2750 x 2500	M 9182	2416	380	620	1210
2896 x 2000	I 9666	2124	320	522	1019
2896 x 2125	I 9670	2165	340	555	1084
3000 x 2000	M 91066	2306	331	541	1056
3000 x 2125	M 91070	2304	352	575	1122
3000 x 2250	M 91074	2376	373	609	1189
3000 x 2375	M 91079	2419	394	643	1254
3000 x 2500	M 91082	2498	414	677	1320
3000 x 3000	M 910910	3248	497	811	1584
3048 x 2000	I 1066	2038	337	550	1073
3048 x 2125	I 1070	2081	358	585	1140
3250 x 2000	M 10866	2394	359	587	1144
3250 x 2125	M 10870	2458	381	623	1215
3250 x 2250	M 10874	2537	403	660	1287
3353 x 2000	I 1166	2436	370	605	1180
3353 x 2125	I 1170	2479	394	643	1254
3500 x 2000	M 11666	2607	386	631	1232

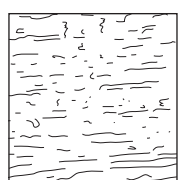
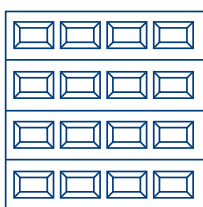

Woodgrain

Georgian design



Premium

Brickwork opening
Width x Height
(mm x mm)

Size
Code

Surcharge
for
Standard
Colours

Surcharge
for
Non-Std.
Colours

Surcharge
for Special
RAL

Brickwork opening Width x Height (mm x mm)	Size Code		Surcharge for Standard Colours	Surcharge for Non-Std. Colours	Surcharge for Special RAL	
3500 x 2125	M	11670	2675	411	670	1310
3500 x 2250	M	11674	2760	435	710	1386
3658 x 2000	I	1266	2874	403	660	1287
3658 x 2125	I	1270	2920	429	701	1368
3750 x 2000	M	12466	2815	414	677	1320
3750 x 2125	M	12470	2888	439	718	1403
3750 x 2250	M	12474	2979	466	761	1486
3962 x 2000	I	1366	2989	437	715	1394
3962 x 2125	I	1370	3030	465	759	1482
4000 x 2000	M	13266	3014	441	721	1408
4000 x 2125	M	13270	3090	469	767	1496
4000 x 2250	M	13274	3189	497	811	1584
4250 x 2000	M	131166	3109	469	767	1496
4250 x 2125	M	131170	3194	499	815	1589
4250 x 2250	M	131174	3291	527	862	1683
4267 x 2000	I	1466	3108	471	769	1503
4267 x 2125	I	1470	3157	501	818	1596
4420 x 2000	I	14666	3220	488	797	1556
4420 x 2125	I	14670	3274	518	846	1653
4500 x 2000	M	14966	3194	497	811	1584
4500 x 2125	M	14970	3290	527	862	1683
4500 x 2250	M	14974	3395	559	913	1782
4572 x 2000	I	1566	3280	504	824	1610
4572 x 2125	I	1570	3333	536	876	1710
4725 x 2000	I	15666	3441	521	852	1664
4725 x 2125	I	15670	3494	554	905	1768
4750 x 2000	M	15766	3291	524	857	1672
4750 x 2125	M	15770	3388	557	910	1777
4750 x 2250	M	15774	3490	590	963	1881
4877 x 2000	I	1666	3441	538	879	1717
4877 x 2125	I	1670	3494	572	934	1824
5000 x 2000	M	16566	3383	552	901	1760
5000 x 2125	M	16570	3461	587	958	1870
5000 x 2250	M	16574	3571	621	1014	1981
5000 x 2375	M	16579	3702	656	1070	2090
5000 x 2500	M	16582	3691	689	1127	2200
5500 x 2000	M	18166	3659	607	992	1936
5500 x 2125	M	18170	3818	645	1053	2057
5500 x 2250	M	18174	4038	683	1116	2178

Prices in bold are generally a stock item. Non-bold prices require a longer lead-time.

Purpose-made sizes available upon request. Non standard colours also available upon request. Doors supplied without locking as standard (see options on page 67 for handles). For window options please see page 49.

- I** Imperial door sizes.
- M** Metric door sizes. Extended lead time of 4-6 weeks.

- Supplied as standard with **tension** spring gear. Torsion spring fitting available for Premium doors at £ 106 surcharge.
- Supplied as standard with **torsion** spring gear. Low headroom fitting available at £ 170 surcharge.

Purpose-made sizes available upon request. Non standard colours also available upon request. Doors supplied without locking as standard (see options on page 67 for handles). For window options please see page 49.

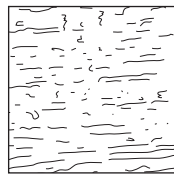
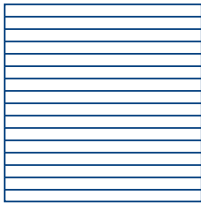

Woodgrain

Linear small design

 Brickwork
opening
Width x Height
(mm x mm)

 Size
Code



Premium

 Surcharge
for
Standard
Colours

 Surcharge
for
Non-Std.
Colours

 Surcharge
for Special
RAL

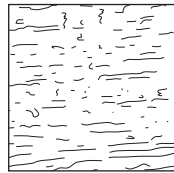
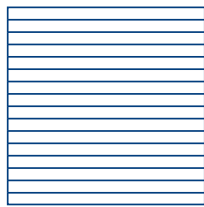
Brickwork opening Width x Height (mm x mm)	Size Code		Premium	Surcharge for Standard Colours	Surcharge for Non-Std. Colours	Surcharge for Special RAL
2080 x 2000	I	61066	1345	229	376	733
2080 x 2080	I	610610	1395	239	391	762
2134 x 2000	I	7066	1394	236	385	751
2134 x 2125	I	7070	1441	251	409	799
2250 x 1875	M	7462	1473	233	381	742
2250 x 2000	M	7466	1518	249	406	792
2250 x 2125	M	7470	1521	264	431	842
2286 x 2000	I	7666	1394	253	413	805
2286 x 2125	I	7670	1441	269	438	855
2286 x 2250	I	7674	1461	284	464	906
2286 x 2375	I	7679	1575	299	489	956
2286 x 2500	I	7682	1572	315	516	1006
2375 x 1875	M	7962	1473	246	402	784
2375 x 2000	M	7966	1475	262	429	837
2375 x 2125	M	7970	1475	278	455	889
2375 x 2250	M	7974	1504	295	482	941
2438 x 2000	I	8066	1464	270	439	858
2438 x 2125	I	8070	1523	286	467	912
2438 x 2250	I	8074	1532	303	494	966
2438 x 2375	I	8079	1651	320	522	1019
2438 x 2500	I	8082	1643	337	550	1073
2500 x 1875	M	8262	1473	259	422	825
2500 x 2000	M	8266	1475	276	451	880
2500 x 2125	M	8270	1475	293	480	935
2500 x 2250	M	8274	1504	311	507	991
2500 x 2375	M	8279	1586	328	536	1046
2500 x 2500	M	8282	1589	345	563	1101
2500 x 2750	M	8290	1932	380	620	1210
2591 x 2000	I	8666	1464	286	467	912
2591 x 2125	I	8670	1523	304	497	969
2625 x 2125	M	8770	1669	308	503	982
2740 x 2000	I	9066	1587	303	494	965
2740 x 2125	I	9070	1641	322	525	1026
2750 x 2000	M	9166	1693	304	497	968
2750 x 2125	M	9170	1747	323	527	1029
2750 x 2250	M	9174	1757	342	558	1089
2750 x 2375	M	9179	1804	361	589	1150
2750 x 2500	M	9182	1884	380	620	1210
2896 x 2000	I	9666	1658	320	522	1019
2896 x 2125	I	9670	1726	340	555	1084
3000 x 2000	M	91066	1900	331	541	1056
3000 x 2125	M	91070	1899	352	575	1122
3000 x 2250	M	91074	1915	373	609	1189
3000 x 2375	M	91079	1966	394	643	1254
3000 x 2500	M	91082	2047	414	677	1320
3000 x 3000	M	910910	2483	497	811	1584
3048 x 2000	I	1066	1602	337	550	1073
3048 x 2125	I	1070	1660	358	585	1140
3250 x 2000	M	10866	1911	359	587	1144
3250 x 2125	M	10870	1966	381	623	1215
3250 x 2250	M	10874	2009	403	660	1287
3353 x 2000	I	1166	1889	370	605	1180
3353 x 2125	I	1170	1966	394	643	1254
3500 x 2000	M	11666	2041	386	631	1232



Woodgrain

Linear small design



Premium

Brickwork opening Width x Height (mm x mm)	Size Code			Surcharge for Standard Colours	Surcharge for Non-Std. Colours	Surcharge for Special RAL
3500 x 2125	M	11670	2092	411	670	1310
3500 x 2250	M	11674	2137	435	710	1386
3658 x 2000	I	1266	2222	403	660	1287
3658 x 2125	I	1270	2309	429	701	1368
3750 x 2000	M	12466	2153	414	677	1320
3750 x 2125	M	12470	2217	439	718	1403
3750 x 2250	M	12474	2260	466	761	1486
3962 x 2000	I	1366	2305	437	715	1394
3962 x 2125	I	1370	2392	465	759	1482
4000 x 2000	M	13266	2269	441	721	1408
4000 x 2125	M	13270	2338	469	767	1496
4000 x 2250	M	13274	2387	497	811	1584
4250 x 2000	M	131166	2397	469	767	1496
4250 x 2125	M	131170	2467	499	815	1589
4250 x 2250	M	131174	2521	527	862	1683
4267 x 2000	I	1466	2391	471	769	1503
4267 x 2125	I	1470	2486	501	818	1596
4420 x 2000	I	14666	2471	488	797	1556
4420 x 2125	I	14670	2571	518	846	1653
4500 x 2000	M	14966	2519	497	811	1584
4500 x 2125	M	14970	2593	527	862	1683
4500 x 2250	M	14974	2644	559	913	1782
4572 x 2000	I	1566	2517	504	824	1610
4572 x 2125	I	1570	2616	536	876	1710
4725 x 2000	I	15666	2624	521	852	1664
4725 x 2125	I	15670	2727	554	905	1768
4750 x 2000	M	15766	2596	524	857	1672
4750 x 2125	M	15770	2671	557	910	1777
4750 x 2250	M	15774	2724	590	963	1881
4877 x 2000	I	1666	2624	538	879	1717
4877 x 2125	I	1670	2727	572	934	1824
5000 x 2000	M	16566	2672	552	901	1760
5000 x 2125	M	16570	2727	587	958	1870
5000 x 2250	M	16574	2781	621	1014	1981
5000 x 2375	M	16579	2839	656	1070	2090
5000 x 2500	M	16582	2896	689	1127	2200
5500 x 2000	M	18166	2858	607	992	1936
5500 x 2125	M	18170	2937	645	1053	2057
5500 x 2250	M	18174	3011	683	1116	2178

Prices in bold are generally a stock item. Non-bold prices require a longer lead-time.

- I** Imperial door sizes.
- M** Metric door sizes. Extended lead time of 4-6 weeks.
- Supplied as standard with **tension** spring gear. Torsion spring fitting available for Premium doors at £ 106 surcharge.
- Supplied as standard with **torsion** spring gear. Low headroom fitting available at £ 170 surcharge.

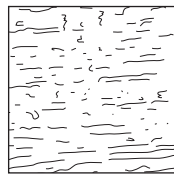
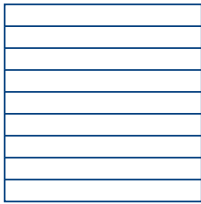

Woodgrain

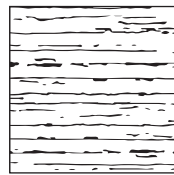
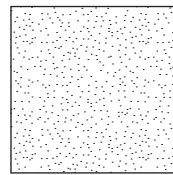
 Slategrain¹

 Silkgrain²
Linear medium design

 Brickwork
opening
Width x Height
(mm x mm)

 Size
Code

Premium



Premium







Premium

 Surcharge
for
Standard
Colours

 Surcharge
for
Non-Std.
Colours

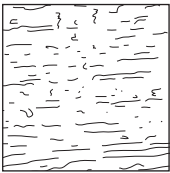
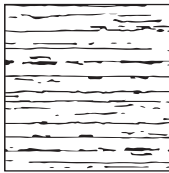
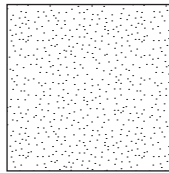
 Surcharge
for Special
RAL



Brickwork opening Width x Height (mm x mm)	Size Code	Premium	Premium	Premium	Surcharge for Standard Colours	Surcharge for Non-Std. Colours	Surcharge for Special RAL
2080 x 2000	I 61066	1345	1345	1654	229	376	733
2080 x 2080	I 610610	1395	1395	1719	239	391	762
2134 x 2000	I 7066	1394	1394	1654	236	385	751
2134 x 2125	I 7070	1441	1441	1719	251	409	799
2250 x 1875	M 7462	1441	1473	1764	233	381	742
2250 x 2000	M 7466	1518	1518	1798	249	406	792
2250 x 2125	M 7470	1521	1521	1801	264	431	842
2286 x 2000	I 7666	1394	1394	1654	253	413	805
2286 x 2125	I 7670	1441	1441	1719	269	438	855
2286 x 2250	I 7674	1461	1461	1799	284	464	906
2286 x 2375	I 7679	1575	1575	1878	299	489	956
2286 x 2500	I 7682	1572	1572	1952	315	516	1006
2375 x 1875	M 7962	1473	1473	1764	246	402	784
2375 x 2000	M 7966	1475	1475	1769	262	429	837
2375 x 2125	M 7970	1475	1475	1773	278	455	889
2375 x 2250	M 7974	1504	1504	1839	295	482	941
2438 x 2000	I 8066	1464	1464	1753	270	439	858
2438 x 2125	I 8070	1523	1523	1826	286	467	912
2438 x 2250	I 8074	1532	1532	1879	303	494	966
2438 x 2375	I 8079	1651	1651	1968	320	522	1019
2438 x 2500	I 8082	1643	1643	2059	337	550	1073
2500 x 1875	M 8262	1473	1473	1764	259	422	825
2500 x 2000	M 8266	1475	1475	1769	276	451	880
2500 x 2125	M 8270	1475	1475	1773	293	480	935
2500 x 2250	M 8274	1504	1504	1839	311	507	991
2500 x 2375	M 8279	1586	1586	1956	328	536	1046
2500 x 2500	M 8282	1589	1589	1954	345	563	1101
2500 x 2750	M 8290	1932	1932	-	380	620	1210
2591 x 2000	I 8666	1464	1464	1753	286	467	912
2591 x 2125	I 8670	1523	1523	1826	304	497	969
2625 x 2125	M 8770	1669	1669	2028	308	503	982
2740 x 2000	I 9066	1587	1587	1921	303	494	965
2740 x 2125	I 9070	1641	1641	1995	322	525	1026
2750 x 2000	M 9166	1693	1693	1993	304	497	968
2750 x 2125	M 9170	1747	1747	2072	323	527	1029
2750 x 2250	M 9174	1757	1757	2118	342	558	1089
2750 x 2375	M 9179	1804	1804	2189	361	589	1150
2750 x 2500	M 9182	1884	1884	2288	380	620	1210
2896 x 2000	I 9666	1658	1658	2023	320	522	1019
2896 x 2125	I 9670	1726	1726	2101	340	555	1084
3000 x 2000	M 91066	1900	1900	2271	331	541	1056
3000 x 2125	M 91070	1899	1899	2273	352	575	1122
3000 x 2250	M 91074	1915	1915	2296	373	609	1189
3000 x 2375	M 91079	1966	1966	2400	394	643	1254
3000 x 2500	M 91082	2047	2047	2504	414	677	1320
3000 x 3000	M 910910	2484	2484	3031	497	811	1584
3048 x 2000	I 1066	1602	1602	2023	337	550	1073
3048 x 2125	I 1070	1660	1660	2101	358	585	1140
3250 x 2000	M 10866	1911	1911	2406	359	587	1144
3250 x 2125	M 10870	1966	1966	2475	381	623	1215
3250 x 2250	M 10874	2009	2009	2542	403	660	1287
3353 x 2000	I 1166	1889	1889	2418	370	605	1180
3353 x 2125	I 1170	1966	1966	2516	394	643	1254
3500 x 2000	M 11666	2041	2041	2557	386	631	1232
3500 x 2125	M 11670	2092	2092	2626	411	670	1310
3500 x 2250	M 11674	2137	2137	2705	435	710	1386

							
		Woodgrain	Slategrain ¹	Silkgrain ²			
Linear medium design					Surcharge for Standard Colours	Surcharge for Non-Std. Colours	Surcharge for Special RAL
Brickwork opening Width x Height (mm x mm)	Size Code	Premium	Premium	Premium			
3658 x 2000	I 1266	2222	2222	2729	403	660	1287
3658 x 2125	I 1270	2309	2309	2836	429	701	1368
3750 x 2000	M 12466	2153	2153	2616	414	677	1320
3750 x 2125	M 12470	2217	2217	2699	439	718	1403
3750 x 2250	M 12474	2260	2260	2782	466	761	1486
3962 x 2000	I 1366	2305	2305	2814	437	715	1394
3962 x 2125	I 1370	2392	2392	2920	465	759	1482
4000 x 2000	M 13266	2269	2269	2752	441	721	1408
4000 x 2125	M 13270	2338	2338	2821	469	767	1496
4000 x 2250	M 13274	2387	2387	2913	497	811	1584
4250 x 2000	M 131166	2397	2397	2869	469	767	1496
4250 x 2125	M 131170	2467	2467	2959	499	815	1589
4250 x 2250	M 131174	2521	2521	3045	527	862	1683
4267 x 2000	I 1466	2391	2391	2895	471	769	1503
4267 x 2125	I 1470	2486	2486	3014	501	818	1596
4420 x 2000	I 14666	2471	2471	2971	488	797	1556
4420 x 2125	I 14670	2571	2571	3091	518	846	1653
4500 x 2000	M 14966	2519	2519	3017	497	811	1584
4500 x 2125	M 14970	2593	2593	3111	527	862	1683
4500 x 2250	M 14974	2644	2644	3179	559	913	1782
4572 x 2000	I 1566	2517	2517	2992	504	824	1610
4572 x 2125	I 1570	2616	2616	3121	536	876	1710
4725 x 2000	I 15666	2624	2624	3053	521	852	1664
4725 x 2125	I 15670	2727	2727	3170	554	905	1768
4750 x 2000	M 15766	2596	2596	3079	524	857	1672
4750 x 2125	M 15770	2671	2671	3179	557	910	1777
4750 x 2250	M 15774	2724	2724	3268	590	963	1881
4877 x 2000	I 1666	2624	2624	3105	538	879	1717
4877 x 2125	I 1670	2727	2727	3230	572	934	1824
5000 x 2000	M 16566	2672	2672	3199	552	901	1760
5000 x 2125	M 16570	2727	2727	3284	587	958	1870
5000 x 2250	M 16574	2781	2781	3370	621	1014	1981
5000 x 2375	M 16579	2839	2839	3456	656	1070	2090
5000 x 2500	M 16582	2896	2896	3541	689	1127	2200
5500 x 2000	M 18166	2858	2858	3454	607	992	1936
5500 x 2125	M 18170	2937	2937	3547	645	1053	2057
5500 x 2250	M 18174	3011	3011	3637	683	1116	2178

¹ Slategrain surface texture only available in standard RAL colours and Traffic White (RAL 9016).

² Silkgrain surface supplied with tension spring gear up to 3048 mm wide.

Prices in bold are generally a stock item. Non-bold prices require a longer lead-time.

- I** Imperial door sizes.
- M** Metric door sizes. Extended lead time of 4-6 weeks.
-  Supplied as standard with tension spring gear. Torsion spring fitting available for Premium doors at £ 106 surcharge.
-  Supplied as standard with torsion spring gear. Low headroom fitting available at £ 170 surcharge.

Purpose-made sizes available upon request. Non standard colours also available upon request. Doors supplied without locking as standard (see options on page 67 for handles). For window options please see page 49.

For Slategrain models, the door section has a Slategrain texture but the cover profiles and fascia are smooth.

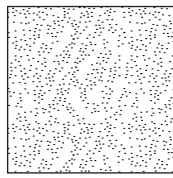
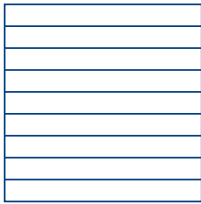
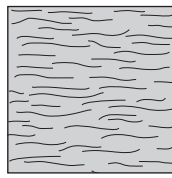
 Sandgrain ¹

 Timber Effect /
Titan (CH 703)

Linear medium design

 Brickwork
opening
Width x Height
(mm x mm)

 Size
Code



Premium



Premium

 Surcharge
for
Standard
Colours

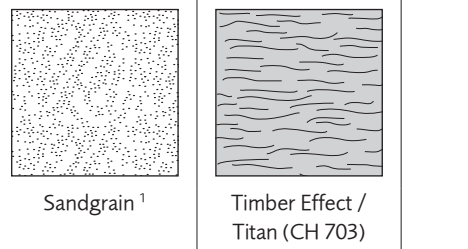
Brickwork opening Width x Height (mm x mm)	Size Code	Premium	Premium	Surcharge for Standard Colours
2080 x 2000	I 61066	1435	1821	229
2080 x 2080	I 610610	1493	1892 ³	239
2134 x 2000	I 7066	1435	1821 ²	236
2134 x 2125	I 7070	1493	1892 ²	251
2250 x 1875	M 7462	1525	1951	233
2250 x 2000	M 7466	1554	1987	249
2250 x 2125	M 7470	1560	1988	264
2286 x 2000	I 7666	1435	1821 ²	253
2286 x 2125	I 7670	1493	1892 ²	269
2286 x 2250	I 7674	1562	1981 ²	284
2286 x 2375	I 7679	1631	2069	299
2286 x 2500	I 7682	1692	2150	315
2375 x 1875	M 7962	1525	1951	246
2375 x 2000	M 7966	1531	1953	262
2375 x 2125	M 7970	1534	1956	278
2375 x 2250	M 7974	1594	2028	295
2438 x 2000	I 8066	1516	1931 ²	270
2438 x 2125	I 8070	1582	2012 ²	286
2438 x 2250	I 8074	1632	2071 ⁴	303
2438 x 2375	I 8079	1703	2170	320
2438 x 2500	I 8082	1781	2271	337
2500 x 1875	M 8262	1525	1951	259
2500 x 2000	M 8266	1531	1953	276
2500 x 2125	M 8270	1534	1956	293
2500 x 2250	M 8274	1594	2028	311
2500 x 2375	M 8279	1692	2161	328
2500 x 2500	M 8282	1695	2157	345
2500 x 2750	M 8290	-	-	380
2591 x 2000	I 8666	1516	1931	286
2591 x 2125	I 8670	1582	2012 ²	304
2625 x 2125	M 8770	1745	2246	308
2740 x 2000	I 9066	1654	2123	303
2740 x 2125	I 9070	1722	2205 ²	322
2750 x 2000	M 9166	1716	2208	304
2750 x 2125	M 9170	1784	2295	323
2750 x 2250	M 9174	1824	2346	342
2750 x 2375	M 9179	1887	2425	361
2750 x 2500	M 9182	1970	2535	380
2896 x 2000	I 9666	1739	2237	320
2896 x 2125	I 9670	1810	2325	340
3000 x 2000	M 91066	1946	3009	331
3000 x 2125	M 91070	1948	2522	352
3000 x 2250	M 91074	1968	2549	373
3000 x 2375	M 91079	2058	2664	394
3000 x 2500	M 91082	2146	2781	414
3000 x 3000	M 910910	2380	3371	497
3048 x 2000	I 1066	1739	2237	337
3048 x 2125	I 1070	1810	2325 ⁴	358
3250 x 2000	M 10866	2055	2676	359
3250 x 2125	M 10870	2114	2753	381
3250 x 2250	M 10874	2175	2829	403
3353 x 2000	I 1166	2069	2685	370
3353 x 2125	I 1170	2148	2794	394
3500 x 2000	M 11666	2181	2849	386
3500 x 2125	M 11670	2240	2925	411
3500 x 2250	M 11674	2308	3012	435
3658 x 2000	I 1266	2326	3037	403
3658 x 2125	I 1270	2418	3157 ⁴	429



Linear medium design

Brickwork opening Width x Height (mm x mm)	Size Code	Premium		Surcharge for Standard Colours	
		2230	2915		
3750 x 2000	M	12466	2230	2915	414
3750 x 2125	M	12470	2302	3009	439
3750 x 2250	M	12474	2369	3101	466
3962 x 2000	I	1366	2394	3133	437
3962 x 2125	I	1370	2481	3252 ⁴	465
4000 x 2000	M	13266	2341	3070	441
4000 x 2125	M	13270	2400	3147	469
4000 x 2250	M	13274	2481	3249	497
4250 x 2000	M	131166	2438	3202	469
4250 x 2125	M	131170	2514	3303	499
4250 x 2250	M	131174	2588	3399	527
4267 x 2000	I	1466	2462	3226 ²	471
4267 x 2125	I	1470	2561	3359 ²	501
4420 x 2000	I	14666	2524	3312	488
4420 x 2125	I	14670	2627	3447 ²	518
4500 x 2000	M	14966	2560	3371	497
4500 x 2125	M	14970	2641	3475	527
4500 x 2250	M	14974	2699	3551	559
4572 x 2000	I	1566	2542	3335	504
4572 x 2125	I	1570	2652	3479	536
4725 x 2000	I	15666	2589	3404	521
4725 x 2125	I	15670	2692	3536 ⁴	554
4750 x 2000	M	15766	2611	3441	524
4750 x 2125	M	15770	2696	3554	557
4750 x 2250	M	15774	2772	3652	590
4877 x 2000	I	1666	2638	3464	538
4877 x 2125	I	1670	2740	3603 ²	572
5000 x 2000	M	16566	2711	3577	552
5000 x 2125	M	16570	2784	3672	587
5000 x 2250	M	16574	2853	3768	621
5000 x 2375	M	16579	2929	3863	656
5000 x 2500	M	16582	2998	3957	689
5500 x 2000	M	18166	2920	3866	607
5500 x 2125	M	18170	3000	3971	645
5500 x 2250	M	18174	3078	4072	683

¹ Sandgrain surface available in Traffic White (RAL 9016) and Anthracite Grey (RAL 7016).

² Available as stock door in Rosewood or Golden Oak timber effect.

³ Available as stock door in Rosewood timber effect.

⁴ Available as stock door in Golden Oak timber effect.

Prices in bold are generally a stock item. Non-bold prices require a longer lead-time.

- I** Imperial door sizes.
- M** Metric door sizes. Extended lead time of 4-6 weeks.



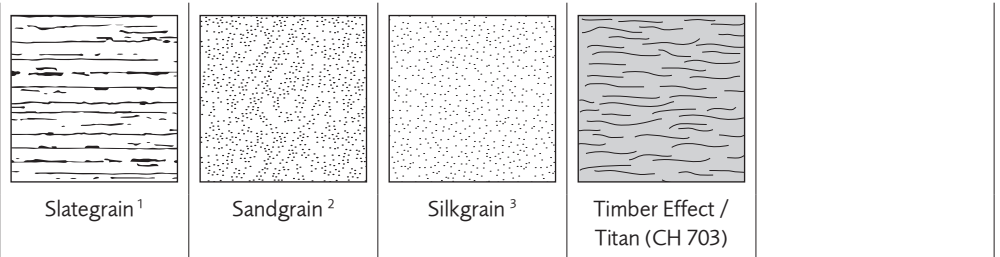
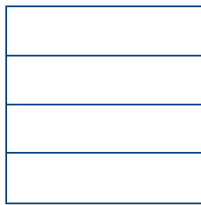

- Supplied as standard with **tension** spring gear. Torsion spring fitting available for Premium doors at £ 106 surcharge.
- Supplied as standard with **torsion** spring gear. Low headroom fitting available at £ 170 surcharge.

Purpose-made sizes available upon request. Non standard colours also available upon request. Doors supplied without locking as standard (see options on page 67 for handles). For window options please see page 49.

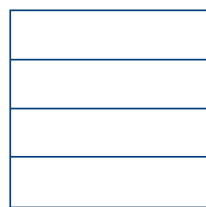
Linear large design

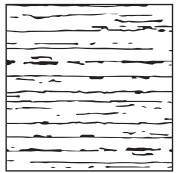
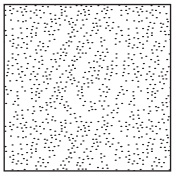
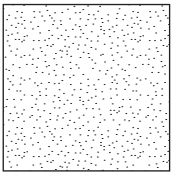
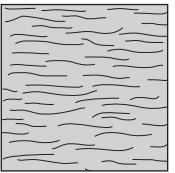
Brickwork opening Width x Height (mm x mm)	Size Code					Surcharge for Standard Colours	Surcharge for Non-Std. Colours	Surcharge for Special RAL
		Premium	Premium	Premium	Premium			
2080 x 2000	I 61066	1477	1672	1854	2035	229	376	733
2080 x 2080	I 610610	1532	1694	1877	2058	239	391	762
2134 x 2000	I 7066	1532	1672	1854	2035	236	385	751
2134 x 2125	I 7070	1585	1694	1877	2058	251	409	799
2250 x 1875	M 7462	1633	1766	1965	2161	233	381	742
2250 x 2000	M 7466	1678	1801	2000	2197	249	406	792
2250 x 2125	M 7470	1678	1802	2003	2199	264	431	842
2286 x 2000	I 7666	1532	1672	1854	2035	253	413	805
2286 x 2125	I 7670	1585	1694	1877	2058 ⁴	269	438	855
2286 x 2250	I 7674	1603	1765	1960	2151	284	464	906
2286 x 2375	I 7679	1733	1776	1968	2158	299	489	956
2286 x 2500	I 7682	1727	1824	2017	2211	315	516	1006
2375 x 1875	M 7962	1633	1766	1965	2161	246	402	784
2375 x 2000	M 7966	1629	1774	1971	2165	262	429	837
2375 x 2125	M 7970	1632	1778	1973	2166	278	455	889
2375 x 2250	M 7974	1658	1833	2031	2231	295	482	941
2438 x 2000	I 8066	1613	1766	1958	2152	270	439	858
2438 x 2125	I 8070	1677	1798	1999	2196 ⁵	286	467	912
2438 x 2250	I 8074	1686	1887	2095	2303	303	494	966
2438 x 2375	I 8079	1819	1937	2149	2362	320	522	1019
2438 x 2500	I 8082	1811	1991	2208	2427	337	550	1073
2500 x 1875	M 8262	1633	1766	1965	2161	259	422	825
2500 x 2000	M 8266	1629	1774	1971	2165	276	451	880
2500 x 2125	M 8270	1632	1778	1973	2166	293	480	935
2500 x 2250	M 8274	1658	1833	2031	2231	311	507	991
2500 x 2375	M 8279	1755	1920	2131	2340	328	536	1046
2500 x 2500	M 8282	1754	1923	2132	2339	345	563	1101
2500 x 2750	M 8290	2137	-	-	-	380	620	1210
2591 x 2000	I 8666	1613	1766	1958	2152	286	467	912
2591 x 2125	I 8670	1677	1798	1999	2196	304	497	969
2625 x 2125	M 8770	1852	2043	2278	2510	308	503	982
2740 x 2000	I 9066	1752	1938	2155	2374	303	494	965
2740 x 2125	I 9070	1813	1964	2186	2408	322	525	1026
2750 x 2000	M 9166	1879	2061	2298	2533	304	497	968
2750 x 2125	M 9170	1940	2106	2346	2585	323	527	1029
2750 x 2250	M 9174	1946	2214	2466	2718	342	558	1089
2750 x 2375	M 9179	1996	2263	2523	2781	361	589	1150
2750 x 2500	M 9182	2091	2314	2583	2847	380	620	1210
2896 x 2000	I 9666	1833	2042	2276	2510	320	522	1019
2896 x 2125	I 9670	1910	2073	2309	2544	340	555	1084
3000 x 2000	M 91066	2116	2152	2402	2650	331	541	1056
3000 x 2125	M 91070	2112	2152	2400	2646	352	575	1122
3000 x 2250	M 91074	2130	2236	2495	2750	373	609	1189
3000 x 2375	M 91079	2184	2344	2619	2889	394	643	1254
3000 x 2500	M 91082	2276	2382	2656	2929	414	677	1320
3000 x 3000	M 910910	2772	3212	3599	3982	497	811	1584
3048 x 2000	I 1066	1771	2042	2276	2510	337	550	1073
3048 x 2125	I 1070	1834	2073	2309	2544	358	585	1140
3250 x 2000	M 10866	2132	2462	2756	3049	359	587	1144
3250 x 2125	M 10870	2190	2500	2800	3096	381	623	1215
3250 x 2250	M 10874	2237	2550	2853	3153	403	660	1287
3353 x 2000	I 1166	2098	2418	2708	2995	370	605	1180
3353 x 2125	I 1170	2182	2457	2748	3038	394	643	1254
3500 x 2000	M 11666	2277	2517	2820	3120	386	631	1232
3500 x 2125	M 11670	2335	2566	2875	3180	411	670	1310
3500 x 2250	M 11674	2382	2606	2921	3229	435	710	1386
3658 x 2000	I 1266	2477	2728	3061	3392	403	660	1287
3658 x 2125	I 1270	2574	2778	3117	3454	429	701	1368
3750 x 2000	M 12466	2410	2560	2870	3175	414	677	1320



								
Linear large design								
Brickwork opening Width x Height (mm x mm)	Size Code	Premium	Premium	Premium	Premium	Surcharge for Standard Colours	Surcharge for Non-Std. Colours	Surcharge for Special RAL
3750 x 2125	M 12470	2476	2582	2892	3199	439	718	1403
3750 x 2250	M 12474	2530	2644	2961	3275	466	761	1486
3962 x 2000	I 1366	2571	2812	3159	3503	437	715	1394
3962 x 2125	I 1370	2669	2855	3204	3551	465	759	1482
4000 x 2000	M 13266	2540	2753	3088	3422	441	721	1408
4000 x 2125	M 13270	2616	2823	3171	3512	469	767	1496
4000 x 2250	M 13274	2669	2891	3244	3594	497	811	1584
4250 x 2000	M 131166	2683	2915	3273	3629	469	767	1496
4250 x 2125	M 131170	2763	2973	3341	3703	499	815	1589
4250 x 2250	M 131174	2822	3028	3402	3771	527	862	1683
4267 x 2000	I 1466	2670	2896	3256	3611	471	769	1503
4267 x 2125	I 1470	2777	2945	3310	3670 ⁶	501	818	1596
4420 x 2000	I 14666	2760	2976	3346	3713	488	797	1556
4420 x 2125	I 14670	2872	3026	3398	3770	518	846	1653
4500 x 2000	M 14966	2825	2971	3337	3701	497	811	1584
4500 x 2125	M 14970	2910	3065	3445	3822	527	862	1683
4500 x 2250	M 14974	2966	3134	3527	3912	559	913	1782
4572 x 2000	I 1566	2811	3010	3382	3754	504	824	1610
4572 x 2125	I 1570	2924	3058	3436	3813	536	876	1710
4725 x 2000	I 15666	2935	3061	3444	3824	521	852	1664
4725 x 2125	I 15670	3051	3115	3504	3890	554	905	1768
4750 x 2000	M 15766	2912	3097	3483	3864	524	857	1672
4750 x 2125	M 15770	3001	3170	3565	3956	557	910	1777
4750 x 2250	M 15774	3053	3243	3649	4048	590	963	1881
4877 x 2000	I 1666	2811	3119	3506	3893	538	879	1717
4877 x 2125	I 1670	2924	3172	3568	3962	572	934	1824
5000 x 2000	M 16566	3002	3215	3620	4019	552	901	1760
5000 x 2125	M 16570	3064	3283	3698	4105	587	958	1870
5000 x 2250	M 16574	3123	3358	3782	4197	621	1014	1981
5000 x 2375	M 16579	3183	3438	3869	4293	656	1070	2090
5000 x 2500	M 16582	3242	3524	3960	4394	689	1127	2200
5500 x 2000	M 18166	3217	3344	3765	4182	607	992	1936
5500 x 2125	M 18170	3302	3409	3841	4266	645	1053	2057
5500 x 2250	M 18174	3384	3527	3973	4413	683	1116	2178

¹ Slategrain surface texture only available in standard RAL colours and Traffic White (RAL 9016).

² Sandgrain surface available in Traffic White (RAL 9016) and Anthracite Grey (RAL 7016).

³ Silkgrain surface supplied with tension spring gear up to 3048 mm wide.

⁴ Available as stock door in Rosewood or Titan.

⁵ Available as stock door in Golden Oak timber effect.

⁶ Available as stock door in Rosewood or Golden Oak timber effect.

Prices in bold are generally a stock item. Non-bold prices require a longer lead-time.

I Imperial door sizes.

M Metric door sizes. Extended lead time of 4-6 weeks.

 Supplied as standard with tension spring gear. Torsion spring fitting available for Premium doors at £ 106 surcharge.

 Supplied as standard with torsion spring gear. Low headroom fitting available at £ 170 surcharge.

Purpose-made sizes available upon request. Non standard colours also available upon request. Doors supplied without locking as standard (see options on page 67 for handles). For window options please see page 49.

For Slategrain models, the door section has a Slategrain texture but the cover profiles and fascia are smooth.

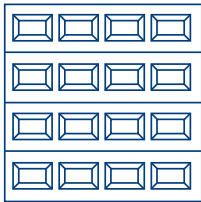

Woodgrain Premium (42 mm insulated)

Georgian design

Door width

Door Height	2000	2250	2375	2500	2750	3000	3250	3500	3750	4000	4250	4500	4750	5000	5250	5500
1875	1928	1935	1965	2143	2335	2515	2678	2927	2973	3031	3115	3185	3265	3331	3424	
1955	1946	1955	1982	2196	2362	2547	2738	2966	3029	3114	3197	3268	3334	3401	3495	
2000	1946	1955	1982	2196	2362	2547	2738	2966	3029	3114	3197	3268	3334	3401	3495	
2080	1957	1968	1993	2226	2397	2563	2802	3000	3081	3197	3284	3352	3398	3470	3566	
2125	1957	1968	1993	2226	2397	2563	2802	3000	3081	3197	3284	3352	3398	3470	3566	
2205	2070	2091	2170	2269	2549	2591	2878	3070	3137	3278	3381	3429	3474	3546	3646	
2250	1987	2009	2083	2179	2446	2591	2878	3070	3137	3278	3381	3429	3474	3546	3646	
2375	2011	2046	2111	2223	2493	2658	2930	3134	3197	3331	3462	3520	3657	3733	3838	
2500	2051	2098	2145	2309	2584	2743	2982	3197	3259	3402	3509	3613	3836	3919	4030	
2625	2111	2154	2185	2399	2688	2834	3069	3262	3324	3486	3683	3793	4027	4115	4230	
2750	2271	2320	2330	2627	2860	2912	3119	3324	3468	3636	3842	3961	4207	4301	4422	
2875	2556	2612	2793	3031	3241	3282	3402	3465	3620	3796	4017	4134	4392	4491	-	
3000	2825	2869	2935	3114	3321	3360	3508	3608	3771	3956	4180	4302	4570	-	-	

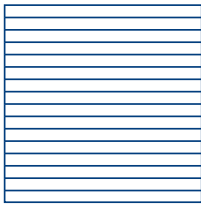

Woodgrain Premium (42 mm insulated)

Linear small design

Door width

Door Height	2000	2250	2375	2500	2750	3000	3250	3500	3750	4000	4250	4500	4750	5000	5250	5500
1875	1442	1487	1529	1712	1923	2045	2214	2220	2316	2416	2508	2595	2684	2831	2938	
1955	1494	1534	1576	1778	1982	2106	2282	2291	2383	2510	2601	2691	2761	2913	3024	
2000	1494	1534	1576	1778	1982	2106	2282	2291	2383	2510	2601	2691	2761	2913	3024	
2080	1537	1574	1618	1826	2035	2165	2345	2366	2451	2583	2689	2782	2837	2993	3104	
2125	1537	1574	1618	1826	2035	2165	2345	2366	2451	2583	2689	2782	2837	2993	3104	
2205	1571	1610	1639	1846	2069	2222	2416	2433	2512	2662	2788	2855	2924	3086	3204	
2250	1571	1610	1639	1846	2069	2222	2416	2433	2512	2662	2788	2855	2924	3086	3204	
2375	1604	1647	1667	1888	2107	2276	2464	2501	2578	2737	2882	2965	3081	3248	3372	
2500	1633	1674	1706	1939	2147	2367	2543	2565	2644	2819	2940	3069	3230	3412	3538	
2625	1683	1726	1770	2036	2236	2457	2604	2644	2709	2899	3086	3219	3389	3578	3713	
2750	1846	1898	1952	2261	2488	2544	2676	2713	2824	3028	3221	3361	3539	3735	3875	
2875	2034	2083	2134	2355	2581	2630	2784	2831	2946	3156	3361	3510	3696	3898	-	
3000	2112	2176	2231	2447	2678	2716	2894	2943	3068	3285	3496	3653	3848	-	-	

■ Supplied with tensions spring as standard. Optional torsion spring available at additional cost, please see page 67.

□ These doors are only available with torsion spring.

For further options please see page 67.

Only fixed door heights are available on Georgian Premium sectional doors.

For intermediate heights, between designated heights in the table above please add £ 167 (for example, a required height of 2175 mm would be taken from the designated height 2205 mm).



Woodgrain Premium (42 mm insulated)

Linear medium design

Door width

Door Height	2000	2250	2375	2500	2750	3000	3250	3500	3750	4000	4250	4500	4750	5000	5250	5500
1875	1477	1526	1568	1763	1984	2125	2294	2300	2401	2501	2593	2688	2779	2882	2991	
1955	1535	1579	1619	1833	2049	2186	2366	2376	2471	2601	2697	2786	2861	2966	3076	
2000	1535	1579	1619	1833	2049	2186	2366	2376	2471	2601	2697	2786	2861	2966	3076	
2080	1585	1622	1665	1884	2100	2247	2433	3088	2540	2679	2784	2877	2939	3047	3159	
2125	1585	1622	1665	1884	2100	2247	2433	2452	2540	2679	2784	2877	2939	3047	3159	
2205	1643	1681	1709	1937	2165	2314	2503	2523	2607	2759	2889	2960	3032	3146	3265	
2250	1643	1681	1709	1937	2165	2314	2503	2523	2607	2759	2889	2960	3032	3146	3265	
2375	1696	1740	1774	2000	2224	2364	2557	2595	2676	2839	2987	3070	3188	3310	3434	
2500	1751	1793	1835	2090	2319	2459	2636	2663	2738	2919	3044	3178	3345	3476	3607	
2625	-	-	-	-	-	-	-	-	-	-	-	-	-	-	-	-
2750	2036	2095	2152	2352	2568	2604	2765	2818	3203	3388	3493	3652	3737	3878	4030	
2875	-	-	-	-	-	-	-	-	-	-	-	-	-	-	-	-
3000	2202	2269	2329	2551	2787	2824	3001	3059	3330	3570	3618	3779	3979	-	-	

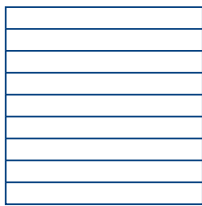

Slategrain Premium (42 mm insulated)

Linear medium design

Door width

Door Height	2000	2250	2375	2500	2750	3000	3250	3500	3750	4000	4250	4500	4750	5000	5250	5500
1875	1477	1526	1568	1763	1984	2125	2294	2300	2401	2501	2593	2688	2779	2882	2991	
1955	1535	1579	1619	1833	2049	2186	2366	2376	2471	2601	2697	2786	2861	2966	3076	
2000	1535	1579	1619	1833	2049	2186	2366	2376	2471	2601	2697	2786	2861	2966	3076	
2080	1585	1622	1665	1884	2100	2247	2433	3088	2540	2679	2784	2877	2939	3047	3159	
2125	1585	1622	1665	1884	2100	2247	2433	2452	2540	2679	2784	2877	2939	3047	3159	
2205	1643	1681	1709	1937	2165	2314	2503	2523	2607	2759	2889	2960	3032	3146	3265	
2250	1643	1681	1709	1937	2165	2314	2503	2523	2607	2759	2889	2960	3032	3146	3265	
2375	1696	1740	1774	2000	2224	2364	2557	2595	2676	2839	2987	3070	3188	3310	3434	
2500	1751	1793	1835	2090	2319	2459	2636	2663	2738	2919	3044	3178	3345	3476	3607	
2625	-	-	-	-	-	-	-	-	-	-	-	-	-	-	-	-
2750	2036	2095	2152	2352	2568	2604	2765	2818	3203	3388	3493	3652	3737	3878	4030	
2875	-	-	-	-	-	-	-	-	-	-	-	-	-	-	-	-
3000	2202	2269	2329	2551	2787	2824	3001	3059	3330	3570	3618	3779	3979	-	-	

Supplied with tensions spring as standard. Optional torsion spring available at additional cost, please see page 67.

These doors are only available with torsion spring.

For further options please see page 67.

For intermediate heights, between designated heights in the table above please add £ 167 (for example, a required height of 2175 mm would be taken from the designated height 2205 mm).

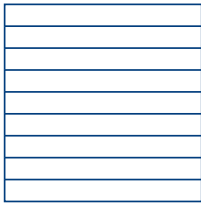

Sandgrain Premium (42 mm insulated)

Linear medium design

Door width

Door Height	2000	2250	2375	2500	2750	3000	3250	3500	3750	4000	4250	4500	4750	5000	5250	5500
1875	1477	1526	1568	1763	1984	2125	2294	2300	2401	2501	2593	2688	2779	2882	2991	
1955	1535	1579	1619	1833	2049	2186	2366	2376	2471	2601	2697	2786	2861	2966	3076	
2000	1535	1579	1619	1833	2049	2186	2366	2376	2471	2601	2697	2786	2861	2966	3076	
2080	1585	1622	1665	1884	2100	2247	2433	3088	2540	2679	2784	2877	2939	3047	3159	
2125	1585	1622	1665	1884	2100	2247	2433	2452	2540	2679	2784	2877	2939	3047	3159	
2205	1643	1681	1709	1937	2165	2314	2503	2523	2607	2759	2889	2960	3032	3146	3265	
2250	1643	1681	1709	1937	2165	2314	2503	2523	2607	2759	2889	2960	3032	3146	3265	
2375	1696	1740	1774	2000	2224	2364	2557	2595	2676	2839	2987	3070	3188	3310	3434	
2500	1751	1793	1835	2090	2319	2459	2636	2663	2738	2919	3044	3178	3345	3476	3607	
2625	-	-	-	-	-	-	-	-	-	-	-	-	-	-	-	
2750	2036	2095	2152	2352	2568	2604	2765	2818	3203	3388	3493	3652	3737	3878	4030	
2875	-	-	-	-	-	-	-	-	-	-	-	-	-	-	-	
3000	2202	2269	2329	2551	2787	2824	3001	3059	3330	3570	3618	3779	3979	-	-	

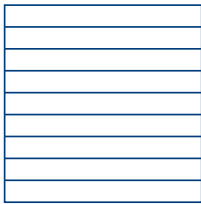

Silkgrain Premium (42 mm insulated)

Linear medium design

Door width

Door Height	2000	2250	2375	2500	2750	3000	3250	3500	3750	4000	4250	4500	4750	5000	5250	5500
1875	1676	1738	1790	2018	2279	2446	2650	2656	2778	2893	3008	3116	3224	3346	3475	
1955	1743	1799	1845	2096	2353	2519	2734	2743	2857	3008	3123	3227	3317	3442	3575	
2000	1743	1799	1845	2096	2353	2519	2734	2743	2857	3008	3123	3227	3317	3442	3575	
2080	1804	1846	1898	2153	2416	2588	2809	2830	2932	3098	3224	3334	3405	3535	3672	
2125	1804	1846	1898	2153	2416	2588	2809	2830	2932	3098	3224	3334	3405	3535	3672	
2205	1868	1914	1945	2216	2487	2666	2890	2911	3012	3188	3345	3429	3515	3649	3790	
2250	1868	1914	1945	2216	2487	2666	2890	2911	3012	3188	3345	3429	3515	3649	3790	
2375	1929	1982	2020	2289	2555	2720	2953	2996	3086	3284	3459	3558	3698	3841	3988	
2500	1992	2043	2091	2392	2664	2829	3041	3073	3166	3376	3525	3682	3879	4035	-	
2625	-	-	-	-	-	-	-	-	-	-	-	-	-	-	-	
2750	2322	2392	2458	2698	2957	2997	3191	3249	3705	3921	4054	4243	-	-	-	
2875	-	-	-	-	-	-	-	-	-	-	-	-	-	-	-	
3000	2518	2594	2666	2927	3206	3253	3464	3530	3855	4138	-	-	-	-	-	

Supplied with tensions spring as standard. Optional torsion spring available at additional cost, please see page 67.
 These doors are only available with torsion spring.

For further options please see page 67.

For intermediate heights, between designated heights in the table above please add £ 167 (for example, a required height of 2175 mm would be taken from the designated height 2205 mm). Sandgrain doors are only available in the following colours: Anthracite Grey (RAL 7016) and Traffic White (RAL 9016). Cost for Sandgrain coloured doors is £ 58 per m². Other colours and RAL to choose are not possible.

For cut-down service on sectional doors less than 2000 mm wide, an additional charge of £ 658 is applied, and on sectional doors more than 2000 mm wide an additional charge of £ 91 is applied. Please check for size limitations.

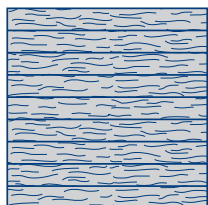

Timber Effect / Titan (CH 703) Premium (42 mm insulated)

Linear medium design

Door Height	Door width															
	2000	2250	2375	2500	2750	3000	3250	3500	3750	4000	4250	4500	4750	5000	5250	5500
1875	1844	1913	1971	2230	2524	2712	2943	2949	3087	3218	3347	3469	3591	3729	3875	
1955	1916	1978	2030	2314	2605	2793	3035	3045	3174	3345	3474	3592	3694	3835	3985	
2000	1916	1978	2030	2314	2605	2793	3035	3045	3174	3345	3474	3592	3694	3835	3985	
2080	1983	2030	2089	2377	2675	2868	3119	3141	3258	3444	3586	3712	3791	3937	4093	
2125	1983	2030	2089	2377	2675	2868	3119	3141	3258	3444	3586	3712	3791	3937	4093	
2205	2054	2105	2141	2446	2752	2955	3207	3231	3345	3544	3721	3815	3914	4065	4224	
2250	2054	2105	2141	2446	2752	2955	3207	3231	3345	3544	3721	3815	3914	4065	4224	
2375	2119	2180	2223	2526	2828	3014	3276	3326	3427	3651	3849	3960	4119	4280	4446	
2500	2190	2249	2303	2642	2949	3135	3374	3412	3515	3753	3921	4100	4322	4497	4673	
2625	-	-	-	-	-	-	-	-	-	-	-	-	-	-	-	
2750	2559	2638	2712	2983	3276	3321	3540	3607	4121	4366	4515	4728	4839	5028	5229	
2875	-	-	-	-	-	-	-	-	-	-	-	-	-	-	-	
3000	2777	2862	2944	3239	3554	3607	3844	3920	4286	4605	4671	4887	5153	-	-	

Supplied with tension spring as standard. Optional torsion spring available at additional cost, please see page 67.

These doors are only available with torsion spring.

For further options please see page 67.

For intermediate heights, between designated heights in the table above please add £ 167 (for example, a required height of 2175 mm would be taken from the designated height 2205 mm).

For cut-down service on sectional doors less than 2000 mm wide, an additional charge of £ 658 is applied, and on sectional doors more than 2000 mm wide an additional charge of £ 91 is applied. Please check for size limitations.

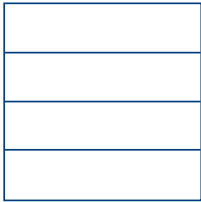

Woodgrain Premium (42 mm insulated)

Linear large design

Door Height	Door width															
	2000	2250	2375	2500	2750	3000	3250	3500	3750	4000	4250	4500	4750	5000	5250	5500
1875	1751	1811	1865	2104	2374	2530	2751	2759	2884	3010	3130	3244	3359	3550	3686	
1955	1814	1866	1916	2179	2446	2606	2832	2847	2965	3129	3246	3362	3451	3648	3789	
2000	1814	1866	1916	2179	2446	2606	2832	2847	2965	3129	3246	3362	3451	3648	3789	
2080	1868	1915	1967	2238	2514	2677	2912	2936	3046	3221	3353	3474	3550	3748	3894	
2125	1868	1915	1967	2238	2514	2677	2912	2936	3046	3221	3353	3474	3550	3748	3894	
2205	1905	1955	1993	2263	2540	2750	2996	3025	3123	3316	3478	3567	3654	3866	4022	
2250	1905	1955	1993	2263	2540	2750	2996	3025	3123	3316	3478	3567	3654	3866	4022	
2375	1949	1995	2023	2310	2591	2814	3056	3105	3206	3408	3595	3705	3856	4070	4231	
2500	1977	2031	2076	2375	2642	2926	3156	3186	3284	3509	3669	3836	4049	4275	4442	
2625	2034	2095	2151	2490	2753	3038	3225	3282	3363	3612	3850	4022	4245	4489	4661	
2750	2241	2310	2380	2781	3076	3149	3316	3366	3511	3772	4021	4206	4438	4689	4870	
2875	2483	2548	2612	2895	3192	3252	3451	3511	3663	3932	4199	4391	4634	4898	-	
3000	2577	2661	2735	3014	3313	3364	3590	3654	3813	4100	4370	4570	4827	-	-	

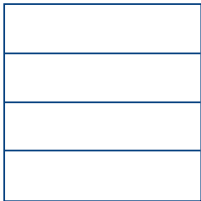

Slategrain Premium (42 mm insulated)

Linear large design

Door Height	Door width															
	2000	2250	2375	2500	2750	3000	3250	3500	3750	4000	4250	4500	4750	5000	5250	5500
1875	1751	1811	1865	2104	2374	2530	2751	2759	2884	3010	3130	3244	3359	3550	3686	
1955	1814	1866	1916	2179	2446	2606	2832	2847	2965	3129	3246	3362	3451	3648	3789	
2000	1814	1866	1916	2179	2446	2606	2832	2847	2965	3129	3246	3362	3451	3648	3789	
2080	1868	1915	1967	2238	2514	2677	2912	2936	3046	3221	3353	3474	3550	3748	3894	
2125	1868	1915	1967	2238	2514	2677	2912	2936	3046	3221	3353	3474	3550	3748	3894	
2205	1905	1955	1993	2263	2540	2750	2996	3025	3123	3316	3478	3567	3654	3866	4022	
2250	1905	1955	1993	2263	2540	2750	2996	3025	3123	3316	3478	3567	3654	3866	4022	
2375	1949	1995	2023	2310	2591	2814	3056	3105	3206	3408	3595	3705	3856	4070	4231	
2500	1977	2031	2076	2375	2642	2926	3156	3186	3284	3509	3669	3836	4049	4275	4442	
2625	-	-	-	-	-	-	-	-	-	-	-	-	-	-	-	
2750	2241	2310	2380	2781	3076	3149	3316	3366	3511	3772	4021	4206	4438	4689	4870	
2875	-	-	-	-	-	-	-	-	-	-	-	-	-	-	-	
3000	2577	2661	2735	3014	3313	3364	3590	3654	3813	4100	4370	4570	4827	-	-	

Supplied with tension spring as standard. Optional torsion spring available at additional cost, please see page 67.

These doors are only available with torsion spring.

For further options please see page 67.

For intermediate heights, between designated heights in the table above please add £ 167 (for example, a required height of 2175 mm would be taken from the designated height 2205 mm).

For cut-down service on sectional doors less than 2000 mm wide, an additional charge of £ 658 is applied, and on sectional doors more than 2000 mm wide an additional charge of £ 91 is applied. Please check for size limitations.

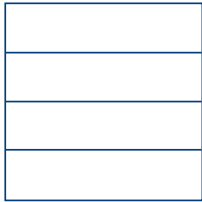

Sandgrain Premium (42 mm insulated)

Linear large design

Door Height	Door width															
	2000	2250	2375	2500	2750	3000	3250	3500	3750	4000	4250	4500	4750	5000	5250	5500
1875	1858	1868	1879	2067	2266	2454	2522	2558	2575	2735	2818	2888	2912	2963	3020	
1955	1889	1892	1905	2124	2348	2539	2600	2646	2771	2841	2912	3068	3096	3149	3208	
2000	1889	1817	1905	2124	2348	2539	2600	2646	2771	2841	2912	3068	3096	3149	3208	
2080	1912	1915	1920	2171	2387	2584	2652	2663	2825	2919	3009	3117	3170	3226	3289	
2125	1912	1915	1920	2171	2387	2584	2652	2663	2825	2919	3009	3117	3170	3226	3289	
2205	1950	1966	1993	2282	2510	2632	2693	2733	2909	2990	3094	3192	3241	3299	3363	
2250	1950	1966	1993	2282	2510	2632	2693	2733	2909	2990	3094	3192	3241	3299	3363	
2375	1965	1982	2036	2334	2532	2683	2748	2826	2987	3066	3180	3310	3409	3474	3542	
2500	1977	2019	2083	2387	2569	2723	2790	2872	3045	3138	3272	3395	3581	3645	3718	
2625	-	-	-	-	-	-	-	-	-	-	-	-	-	-	-	
2750	2128	2175	2254	2634	2787	2871	2926	3034	3247	3365	3581	3717	3924	3996	4077	
2875	-	-	-	-	-	-	-	-	-	-	-	-	-	-	-	
3000	2563	2618	2648	2910	3060	3139	3199	3294	3522	3655	3892	4039	4266	-	-	

 Supplied with tension spring as standard. Optional torsion spring available at additional cost, please see page 67.

 These doors are only available with torsion spring.

For further options please see page 67.

For intermediate heights, between designated heights in the table above please add £ 167 (for example, a required height of 2175 mm would be taken from the designated height 2205 mm).

Heights between 2505 mm - 2570 mm and 2755 mm - 2870 mm are not available in Sandgrain. Sandgrain doors are only available in the following colours: Anthracite Grey (RAL 7016) and Traffic White (RAL 9016). Cost for Sandgrain coloured doors is £ 58 per m². Other colours and RAL to choose are not possible. For sectional doors less than 2000 mm wide, an additional charge of £ 658 is applied for the cut-down service.

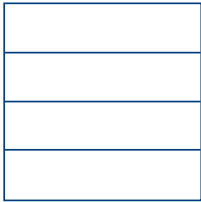

Silkgrain Premium (42 mm insulated)

Linear large design

Door Height	Door width															
	2000	2250	2375	2500	2750	3000	3250	3500	3750	4000	4250	4500	4750	5000	5250	5500
1875	2062	2074	2086	2303	2526	2742	2818	2859	2878	3061	3155	3233	3261	3320	3383	
1955	2093	2097	2112	2363	2617	2835	2902	2956	3098	3177	3259	3436	3465	3529	3596	
2000	2093	2097	2112	2363	2617	2835	2902	2956	3098	3177	3259	3436	3465	3529	3596	
2080	2115	2120	2127	2413	2660	2879	2957	2976	3156	3265	3368	3486	3652	3614	3687	
2125	2115	2120	2127	2413	2660	2879	2957	2976	3156	3265	3368	3486	3652	3614	3687	
2205	2158	2178	2206	2537	2798	2935	3001	3049	3252	3339	3460	3572	3630	3698	3770	
2250	2158	2178	2206	2537	2798	2935	3001	3049	3252	3339	3460	3572	3630	3698	3770	
2375	2173	2195	2253	2593	2820	2989	3067	3152	3337	3429	3560	3706	3824	3893	3971	
2500	2186	2195	2308	2654	2862	3033	3112	3207	3402	3508	3662	3802	4010	4083	-	
2625	-	-	-	-	-	-	-	-	-	-	-	-	-	-	-	
2750	2355	2410	2497	2611	3102	3262	3262	3384	3625	3761	4010	4162	-	-	-	
2875	-	-	-	-	-	-	-	-	-	-	-	-	-	-	-	
3000	2844	2905	2943	3239	3412	3568	3568	3679	3939	4091	-	-	-	-	-	

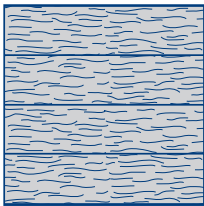

Timber Effect / Titan (CH 703) Premium (42 mm insulated)

Linear large design

Door Height	Door width															
	2000	2250	2375	2500	2750	3000	3250	3500	3750	4000	4250	4500	4750	5000	5250	5500
1875	2245	2257	2270	2512	2761	2999	3084	3129	3150	3352	3457	3544	3575	3641	3709	
1955	2277	2282	2299	2576	2858	3100	3174	3233	3391	3479	3570	3766	3798	3869	3944	
2000	2277	2282	2299	2576	2858	3100	3174	3233	3391	3479	3570	3766	3798	3869	3944	
2080	2301	2306	2313	2630	2904	3148	3233	3255	3454	3576	3689	3821	3888	3962	4043	
2125	2301	2306	2313	2630	2904	3148	3233	3255	3454	3576	3689	3821	3888	3962	4043	
2205	2345	2367	2400	2766	3055	3208	3282	3333	3559	3655	3791	3914	3978	4054	4133	
2250	2345	2367	2400	2766	3055	3208	3282	3333	3559	3655	3791	3914	3978	4054	4133	
2375	2361	2385	2450	2826	3079	3265	3352	3447	3653	3754	3899	4061	4192	4268	4355	
2500	2375	2427	2510	2893	3124	3314	3401	3507	3723	3841	4010	4165	4398	4478	4571	
2625	-	-	-	-	-	-	-	-	-	-	-	-	-	-	-	
2750	2558	2619	2715	3195	3387	3493	3564	3699	3966	4119	4394	4563	4826	4914	5016	
2875	-	-	-	-	-	-	-	-	-	-	-	-	-	-	-	
3000	3098	3165	3208	3536	3727	3827	3901	4023	4312	4480	4775	4964	5249	-	-	

Supplied with tension spring as standard. Optional torsion spring available at additional cost, please see page 67.

These doors are only available with torsion spring.

For further options please see page 67.

For intermediate heights, between designated heights in the table above please add £ 167 (for example, a required height of 2175 mm would be taken from the designated height 2205 mm). Please note, heights between 2505 mm - 2570 mm and 2755 mm - 2870 mm are not available in Silkgrain, Timber Effect and Titan (CH 703) doors.

For cut-down service on sectional doors less than 2000 mm wide, an additional charge of £ 658 is applied, and on sectional doors more than 2000 mm wide an additional charge of £ 91 is applied. Please check for size limitations.

Options for sectional doors

add

Special anchor set (required if you fix the door between brickwork and fasten the frame on the side).

If using special anchor set 90 mm cover profiles will be required to cover fixing holes. Two anchor sets are required for doors over 2250mm high.

74

Please note: Frame legs for brown and any coloured doors come in white as standard, matching cover profiles are available. Silkgrain, Foil Coated Timber Effect and Titan Metallic (CH 703) are available ex-stock. Please however note Colours and RAL to choose must be ordered with the door and cannot be ordered as a spare part at a later time.

Cover Profiles

Door height	White				Standard Colour				RAL to choose				Special RAL				Foil Coated Timber Effect / Titan (CH 703)	
	Woodgrain		Sandgrain/ Silkgrain/ Slategrain		Woodgrain		Sandgrain/ Silkgrain/ Slategrain (Smooth)		Woodgrain		Silkgrain (Smooth)		Woodgrain		Silkgrain		55	90
1875	80	112	84	122	93	140	114	146	134	198	140	214	148	233	155	249	125	156
2000	85	119	90	130	98	149	121	155	143	210	149	227	157	249	166	265	132	166
2125	91	127	96	138	104	158	130	166	152	224	158	242	167	263	175	281	140	176
2250	96	134	101	147	111	168	137	175	161	237	168	256	178	279	186	298	149	187
2375	101	141	106	154	117	178	145	185	170	251	178	271	186	294	197	314	157	198
2500	106	149	112	163	122	186	152	194	179	263	186	285	197	310	207	331	165	207
For door heights not specified above, use formula: door height x price below (i.e. door height 2600 for "White Woodgrain 55": 2.6 x 43 = £ 111.8)																		
	43	60	45	65	49	75	61	78	79	125	75	114	79	125	83	133	66	83

Purpose-made width cut-down service (check for size limitations).	91
Purpose-made height cut-down service (check for size limitations).	133
Classic black handle set and lock for on-site installation	85
White finish cast aluminium handle set and lock for on-site installation	232
Brushed stainless steel finish cast aluminium handle set and lock for on-site installation	232
Brown finish cast aluminium handle set and lock for on-site installation	232
Factory cut hole for handle and lock available with a 2 week increase in lead-time (complete with classic black handle as standard) ¹	129
Standard headroom torsion spring for sectional door less than 4000 mm wide ²	103
Low headroom tracks arrangement for torsion spring door over 4000 mm wide (when purchased with door) ²	170

¹ Please note: Only available for stock doors (highlighted in bold) on pages 50 - 59.

² Excluding Silkgrain. For Silkgrain surface finish, torsion spring gear can only be supplied on doors over 3050 mm wide.

For cut-down service on sectional doors less than 2000 mm wide, an additional charge of £ 658 is applied, and on sectional doors more than 2000 mm wide an additional charge of £ 91 is applied. Please check for size limitations.

ThermoFrame set

ThermoFrame set 4

RM height	up to 3000 mm	3x plastic angle profiles	Length 3210 mm	per set	419
LZ width	up to 3210 mm				

ThermoFrame set 5

RM height	up to 3000 mm	2x plastic angle profiles	Length 3210 mm	per set	419
LZ width	from 3210 mm up to 6000 mm	1x plastic angle profile	Length 6000 mm		

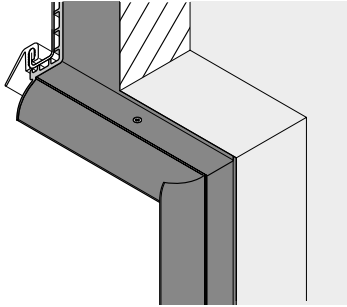

Set consists of

- 3x Plastic angle profiles black 84 x 22.5 mm with lip seal

Note on set 4 and 5 (frame covering not possible):

- A single-skinned fascia panel is fitted. Required headroom corresponds with track application Z, N and L.
- Please also note the supplements and limitations in the technical manual!

Options for purpose-made sectional doors

Standard colour finish for purpose made sectional doors (i.e. 2000 mm x 2125 mm is an area of 4.25 m ²)	per m ²	56
RAL to choose or CH 703 colour finish for purpose made sectional doors	per m ²	91
Special colour finish for purpose made sectional doors	per m ²	176
Top fascia for sectional doors (95 mm). Woodgrain surface texture (Traffic White RAL 9016)	per m	42
Top fascia for sectional doors (95 mm). Sandgrain surface texture (Traffic White RAL 9016)	per m	47
Top fascia for sectional doors (95 mm). Silkgrain surface texture (Traffic White RAL 9016)	per m	47
Top fascia for sectional doors (95 mm). Timber Effect surface texture (Timber Effect and CH 703)	per m	67
Top fascia for sectional doors (95 mm). Standard colour finish	per m ²	56
Top fascia for sectional doors (95 mm). RAL to choose or CH 703	per m ²	91
Top fascia for sectional doors (95 mm). Special RAL colours	per m ²	176

Sectional doors up to 4000 mm wide and/ or 2500 mm high (excluding Silkgrain surface finish) and
 Sectional doors up to 3048 mm wide and/ or 2500 mm high (with Silkgrain surface finish):

These doors come with tension spring fitting. With doors from the Premium range the tension springs can be replaced by torsion springs as an option. Tension springs are suitable for low headroom installations. For a low headroom installation with torsion springs please order low headroom track set separately (changing to a low headroom option is not available as a retrofit).

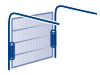

**Sectional garage door
 with tension spring fitting**

Minimum garage dimensions for manually operated doors

Headroom:	100 mm
Sideroom:	90 mm (each side)
Depth into garage:	garage door height + 510 mm
Clear passage height for manually operated doors:	garage door height – 80 mm

Minimum garage dimensions for doors with GaraMatic operator

Headroom	115 mm
Sideroom:	90 mm (each side)
Depth into garage:	for doors up to 2125 mm high: 3200 mm for doors up to 2500 mm high: 3450 mm for doors up to 3000 mm high: 4125 mm

Clear passage height for doors with GaraMatic operator:	garage door height – 30 mm
---	----------------------------

Minimum ceiling height:	115 mm
Minimum ceiling height (with ThermoFrame):	145 mm

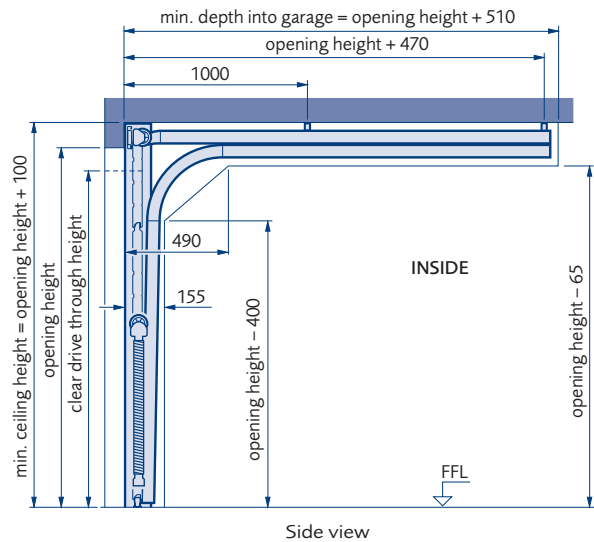

Side view

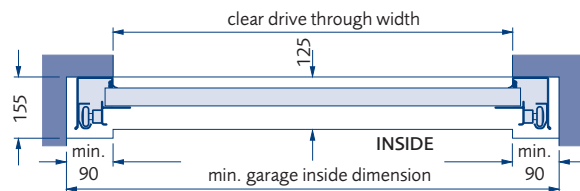

Plan view

Sectional doors with torsion spring fitting wider than 4000 mm wide (excluding Silkgrain surface finish) and
 Sectional doors wider than 3048 mm wide (with Silkgrain surface finish):

These doors come with torsion springs as standard. For a low headroom installation with torsion springs please order low headroom track pack (changing to a low headroom option is not available as a retrofit).



**Sectional garage door
 with torsion spring fitting**

Minimum garage dimensions for manually operated doors

Headroom:	210 mm
Sideroom:	90 mm (each side)
Depth into garage:	garage door height + 510 mm
Clear passage height for manually operated doors:	garage door height – 50 mm

Minimum garage dimensions for doors with GaraMatic operator

Headroom:	210 mm
Sideroom:	90 mm (each side)
Depth into garage:	for doors up to 2125 mm high: 3200 mm for doors up to 2500 mm high: 3450 mm for doors up to 3000 mm high: 4125 mm

Clear passage height
for doors with
GaraMatic operator: full garage door height

Minimum ceiling height:	210 mm
Minimum ceiling height (with ThermoFrame):	255 mm

Excludes Silkgrain surface finish.
 Torsion spring available for doors over 3000 mm x 2250 mm

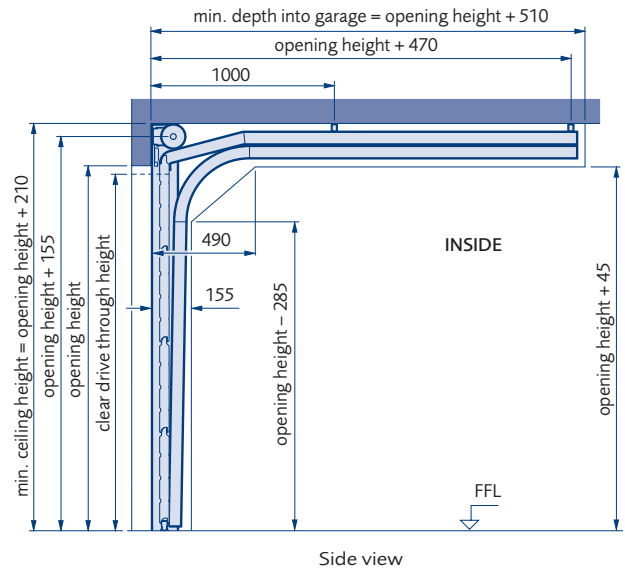

Side view

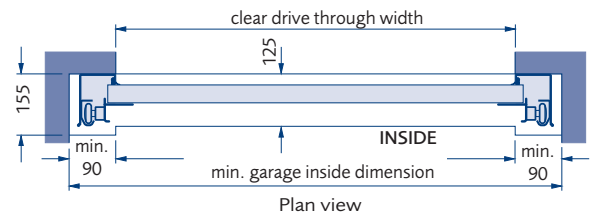

Plan view

Sectional doors with low-headroom torsion spring fitting wider than 4000 mm wide (excluding Silkgrain surface finish) and Sectional doors wider than 3048 mm wide (with Silkgrain surface finish):

These doors come with torsion springs as standard. For a low headroom installation with torsion springs please order low headroom track pack (changing to a low headroom option is not available as a retrofit).

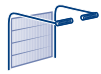

Sectional garage door with low headroom torsion spring fitting

Minimum garage dimensions for manually operated doors

Headroom:	100 mm
Sideroom:	90 mm (each side)
Depth into garage:	garage door height + 510 mm
Clear passage height for manually operated doors:	garage door height – 100 mm

Minimum garage dimensions for doors with GaraMatic operator

Headroom:	115 mm
Sideroom:	90 mm (each side)
Depth into garage:	for doors up to 2125 mm high: 3200 mm for doors up to 3000 mm high: 4125 mm
Clear passage height for doors with GaraMatic operator:	for doors up to 3000 mm wide: garage door height – 30 mm for doors wider than 3000 mm: garage door height – 80 mm

Minimum ceiling height: 115 mm

Minimum ceiling height (with ThermoFrame): 145 mm

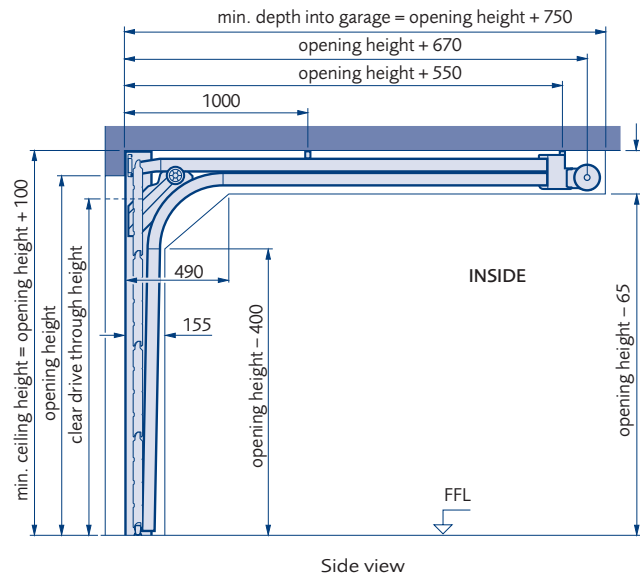

Side view

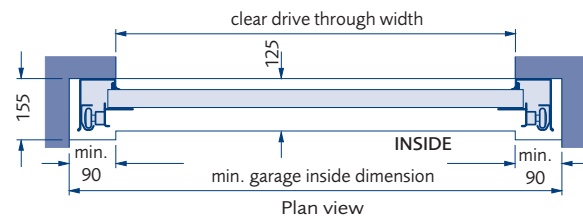

Plan view

Automation and Accessories

Operators

GaraMatic operators are an ideal match for all current Garador up & over and sectional garage doors. They are a tried and tested hardware combination, designed for use with Garador up & over or sectional garage doors, and prepared for easy installation. They feature energy efficient LED light, a power saving mode and a mechanical lock, built into the operator boom, to prevent forced lifting of the door.

What's Included

All GaraMatic operators come as a complete set, including operator head, boom and two 4-button hand transmitters.



BlueSecur App

The Garador BlueSecur app allows you to control your Series 4 GaraMatic operator from your android or ios smartphone. It allows you to operate the open/close, partial opening and integral light functions.



Both the GaraMatic 10 and GaraMatic 20 are supplied complete with an integrated bluetooth receiver, for control via Garador's BlueSecur smartphone app for android and ios devices. One free user key is included. Others available via in-app purchase. Please refer to Garador BlueSecur for pricing. The bluetooth receiver can be switched on and off. An optional bluetooth receiver is available as an add-on for the GaraMatic 9.



BS EN 13241 Compliant





The combination of Garador garage doors with GaraMatic operators complies with the latest European safety standards.





Operators





	GaraMatic 9	GaraMatic 10	GaraMatic 20
			
	<p>Peak forces 750 N</p> <ul style="list-style-type: none"> • Simple to operate • Soft start and stop • Max. opening speed 20 cm/s • Automatic safety reversal • Integral LED light with 10 LEDs • Low power consumption (less than 1 w in stand by mode) • Supplied with two 4-button hand transmitters (black end caps) 	<p>Peak forces 800 N</p> <ul style="list-style-type: none"> • Control element with 2x 7-segment display • Soft start and stop • Max. opening speed 25 cm/s • Automatic safety reversal • Adjustable integral LED light with 20 LEDs • Partial opening function • Self-closing timer option • Integrated bluetooth receiver • HCP interface to connect smarhome systems • Low power consumption (less than 1 w in stand by mode) • Supplied with two 4-button hand transmitters (chrome end caps) • BlueSecur App: One free user key included. Others available via in-app purchase 	<p>Peak forces 1000 N</p> <ul style="list-style-type: none"> • Control element with 2x 7-segment display • Soft start and stop • Max. opening speed 25 cm/s • Automatic safety reversal • Adjustable integral LED light with 30 LEDs • Partial opening function • Self-closing timer option • Integrated bluetooth receiver • HCP interface to connect smarhome systems • Low power consumption (less than 1 w in stand by mode) • Supplied with two 4-button hand transmitters (chrome end caps) • BlueSecur App: One free user key included. Others available via in-app purchase
Canopy Doors ¹	640	805	859
Standard short boom ² Retractable and Sectional Doors up to 2125 mm high	524	647	719
Medium boom ²	559	682	754
Long boom ²	671	794	866





¹ Canopy door price includes bow arm system. GaraMatic 9 supplied with two 2-channel hand transmitters.





² For exact boom requirements see grid on page 77.



Accessories				
Article	Hand transmitter 5-channel (Bi-directional) in matt black	Hand transmitter 4-channel (Bi-directional) in matt black	Hand transmitter 4-channel (Bi-directional) in matt black (chrome caps)	Hand transmitter 5-channel (Bi-directional) in white
Reference No.	7471	7470	6809	6713
Price £	86	66	73	86

Accessories				
Article	Hand transmitter 5-channel (Bi- directional) in black	Hand transmitter 1-channel (Bi- directional) in black	Hand transmitter 4-channel (Bi- directional) in black	Hand transmitter station in black
Reference No.	6714	6710	6779	6719
Price £	86	73	73	13

Accessories				
Article	Hand transmitter station in white	Hand transmitter sun visor/ wall holder	1-channel (Bi-directional) transmitter for car cigarette lighter	2-channel (Bi-directional) transmitter for car cigarette lighter
Reference No.	6720	6784	6782	6783
Price £	13	12	66	66

Accessories				
Article	Hand transmitter 2-channel (Bi-directional) Burl wood	Hand transmitter 2-channel (Bi-directional) Green	IT3 B Wired Wall Console	FIT 2 Bi-directional wireless wall console
Reference No.	6968	6965	8733	6718
Price £	101	101	50	108

Accessories				
Article	IT1 B Wired illuminated push button	Series 4 External Bluetooth Antenna to increase signal range	IT1-1 Internal Push Button	FCT 3 BS Radio code switch
Reference No.	2875	8128	695	6717
Price £	41	103	31	129

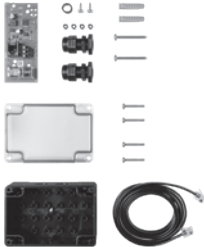
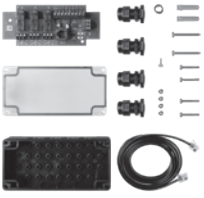
Accessories				
Article	FCT 10 Wireless Code Switch (flip lid) 868 mHz bi-directional	Series 4 External Bluetooth receiver (GaraMatic 9 add-on)	Options relay for control of garage light, warning light or limit switch report HOR-HCP	Series 4 Universal Adapter Print for control of operator light, partial open and venti- lation position UAP-1-HCP
Reference No.	6716	8129	8125	8421
Price £	193	149	64	119

Accessories

			
Article	EL301N External light beam device	Emergency Battery Backup HNA 18-4 (for Series 4 operators)	EL101 Internal light beam device
Reference No.	2884	8126	6786
Price £	155	255	95

Additional options

De-latching kit Reference No. 705 for up & over doors, Garador single door range (437.195) (required to maintain mechanical locking system retractable doors only)	68
De-latching kit Reference No. 2643 for up & over doors, Garador double door range (437.197) (required to maintain mechanical locking system retractable doors only)	112
Emergency release Reference No. 704 for retractable up & over doors only (required if door is electrically operated and has no other personal access)	45
Emergency release Reference No. 703 for sectional door without handle and lock, or canopy up & over doors (required if door is electrically operated and has no other personal access)	63
Emergency release Reference No. 702 for sectional door with handle and lock (required if door is electrically operated and has no other personal access)	64
Lintel extension bracket Reference No. 709 for canopy doors (required if door is fitted between brickwork under the lintel)	63

Operator Specifications

Boom for canopy door including canopy bow arm

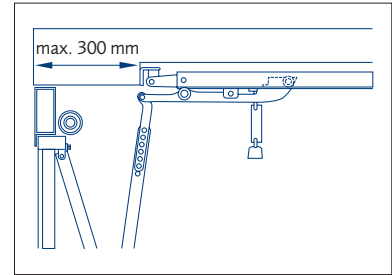
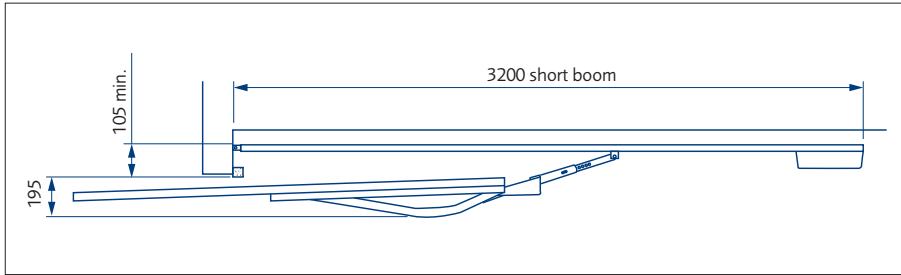

On horizontal doors the bow arm is to be fitted off centre.

Lintel extension bracket required for canopy doors fitted between the brickwork and under the lintel head.

Boom for retractable door

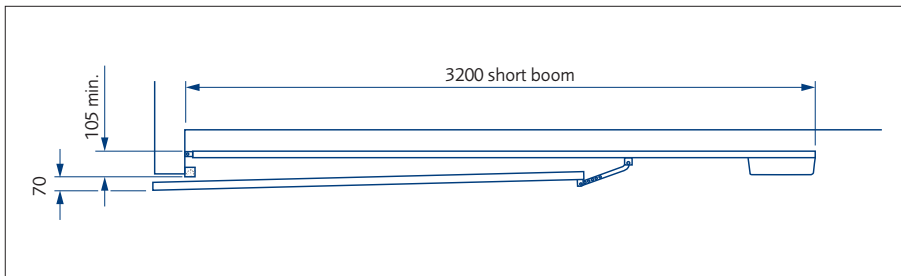

Boom for sectional door

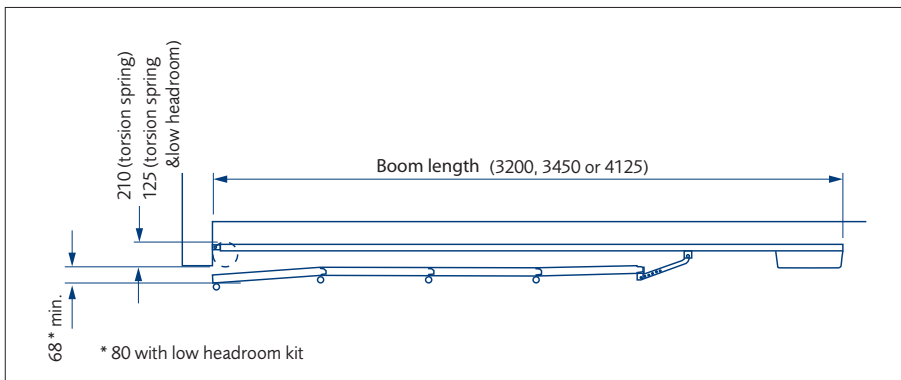

Maximum Door Height to suit Operator Booms

	Torsion Spring	Tension and Low Headroom Spring	Travel distance
Short Boom	2250 mm	2125 mm	2475 mm
Medium Boom	2500 mm	2375 mm	2725 mm
Long Boom	3000 mm	3000 mm	3400 mm

GaraRoll Roller Doors

GaraRoll Insulated Roller Doors

Spring-compensated, automated roller garage door for domestic applications only. All doors are made to suit the opening with the actual door size relating to the structural opening width x height and the guides fitting on the reveals to maintain a full opening size. The GaraRoll is the only roller garage door to include the cover hood, which the curtain rolls into at the head of the garage door opening, as standard. The door is also supplied complete with a DuraBelt anti-scratch system, designed to provide a protective layer between each lath as they roll up when the door is open.

Door curtain

77 mm rolled aluminium profile filled with 100 % CFC-free polyurethane rigid foam. Each lath is 15mm thick. Integrated windlocks fitted as standard.

Surface

Colour finish with double layer coil coating quality paint system or foil-coated timber effect finish.

Frame

Aluminium extrusion profile side guides with integrated plastic runners. Lintel and cover box made of steel. Colour of side guides and lintels supplied to match the door as standard. Except on foil-coated and deco paint timber effect doors where they are supplied in a solid brown paint finish. Cover box coated Grey White (RAL 9002).

Counterbalance

Tension spring technology with lateral integral double tension springs and double cables encased within a transparent cover.

Colours

Same colour inside and outside

- Light Ivory (RAL 1015) - Moss Green (RAL 6005) - Terra Brown (RAL 8028) - White Aluminium (RAL 9006)
- Ruby Red (RAL 3003) - Slate Grey (RAL 7015) - Cream (RAL 9001) - Grey Aluminium (RAL 9007)
- Purple Red (RAL 3004) - Anthracite Grey (RAL 7016) - Jet Black (RAL 9005) - Traffic White (RAL 9016)
- Steel Blue (RAL 5011) - Light Grey (RAL 7035) - Chartwell Green

Deco paint doors available in Anthracite Metallic (Noir 2100 Sable), Golden Oak and Rosewood, with the same finish inside and out.

Foil-coated doors available in Golden Oak and Rosewood, with the inside of the lath in dark brown (foil coat not available on GaraRoll external roller garage door).

Operator and Control

Garador operator and control included. 24 V DC gear drive, mains voltage 230-240 V AC, 0.5 kW, opening speed approx. 11 cm/s, integrated door security kit, operator always located on left (viewed from inside), plastic housing. Micro-processor control in separate plastic housing, automatic teaching of auto safety cut-out and travel limits, soft start and soft stop, light, impulse control, adjustable automatic timer (hold-open time 30 sec. after activation, additional photocell required). Included: 2 hand transmitters and integral receiver, connecting lead with CEE plug, control buttons in cover of the control unit, integrated 2-minute garage light in control housing, quick release (operated from inside). Please note, a wired optical sensor is included as a mandatory safety feature for all GaraRoll doors over 5000 mm wide.

Windows

Window size approx. 120 x 40 mm, number of windows per door section depends on door width. Windows made of clear synthetic pane with black window frame on exterior, transparent frame on interior. Maximum of 10 window sections per door.

Window arrangement:

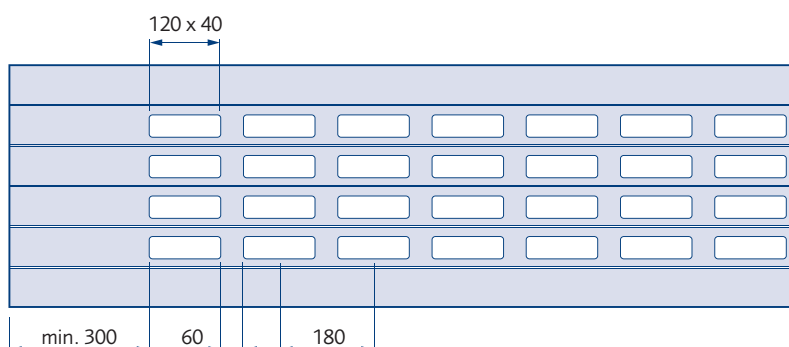

Packaging

GaraRoll doors are supplied in a palletted format shrink wrapped as a complete package.

Stock availability

All GaraRoll doors are made to order with no standard sizes. Lead-time for all doors is 3 to 4 weeks.

Remember the GaraRoll door is measured as opening size and not as overall guide width.

This not only makes it the same as all other Garador doors for sizing but also will probably reduce the price against other doors as most other door manufacturers calculate the price as over guide width thus making the actual door around 220 mm smaller!

Minimum product dimension is 1000 mm x 1600 mm.

Only the door prices highlighted are available with the external roller garage door fitting as an option.

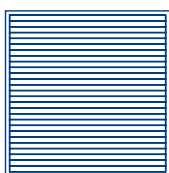

Smooth paint finish

Door width

Door height	1000	1250	1500	1750	1900	2000	2250	2500	2750	3000	3250	3500	3750	4000	4250	4500	4750	5000	5250	5500	5750	6000	
1600																							
1875		2501	2501	2593	2593	2618	2756	2849	2943	2982	3219	3314	3706	3792	3957	4044	4138	4231	4628	4722	4815	4907	
2000		2501	2501	2593	2593	2618	2756	2849	2943	2982	3219	3314	3706	3792	3957	4044	4138	4231	4628	4722	4815	4907	
2125		2501	2501	2593	2593	2709	2875	2921	2999	3081	3327	3432	3858	3894	4122	4213	4307	4398	4795	4886	4979	5072	
2250		2501	2501	2593	2593	2754	2962	3029	3093	3206	3490	3838	3983	4018	4235	4323	4415	4504	4903	4992	5080	5168	
2375		2501	2501	2593	2593	2754	2962	3029	3093	3206	3490	3838	3983	4018	4235	4323	4415	4504	4903	4992	5080	5168	
2500		2669	2669	2808	2808	2847	3009	3105	3218	3307	3602	3979	4053	4209	4375	4468	4560	4648	5045	5131	5222	5311	
2625		2669	2669	2808	2808	2938	3094	3191	3308	3429	3965	4127	4268	4409	4517	4611	4699	4789	-	-	-	-	
2675		2669	2669	2808	2808	2938	3094	3191	3308	3429	3965	4127	4268	4409	4517	4611	4699	4789	-	-	-	-	
2750		-	-	-	2938	3094	3191	3308	3429	3965	4127	4268	4409	-	-	-	-	-	-	-	-	-	
2875		-	-	-	2977	3225	3307	3406	3489	4078	4216	4385	4472	-	-	-	-	-	-	-	-	-	
3000		-	-	-	2977	3225	3307	3406	3489	4078	4216	4385	4472	-	-	-	-	-	-	-	-	-	
3100		-	-	-	2977	3225	3307	3406	3489	4078	4216	4385	4472	-	-	-	-	-	-	-	-	-	

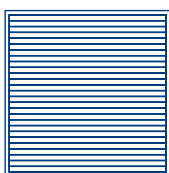

Deco paint finish

Door width

Door height	1000	1250	1500	1750	1900	2000	2250	2500	2750	3000	3250	3500	3750	4000	4250	4500	4750	5000	5250	5500	5750	6000	
1600																							
1875		2596	2616	2727	2597	2770	2928	3040	3153	3211	3467	3581	3992	4097	4282	4388	4500	4613	5029	5141	5254	5365	
2000		2603	2623	2735	2748	2780	3059	3124	3223	3325	3591	3716	4162	4218	4466	4578	4692	4804	5221	5332	5446	5558	
2125		2609	2630	2740	2756	2926	3156	3244	3329	3464	3769	4139	4305	4361	4600	4710	4823	4934	5353	5465	5574	5683	
2250		2614	2638	2752	2766	2936	3167	3256	3342	3478	3785	4155	4323	4380	4620	4731	4846	4958	5379	5490	5602	5712	
2375		2788	2812	2976	2990	3037	3224	3344	3480	3593	3913	4313	4411	4590	4781	4898	5013	5125	5546	5656	5771	5883	
2500		2795	2819	2984	2999	3138	3319	3442	3583	3730	4290	4478	4643	4810	4943	5062	5175	5290	-	-	-	-	
2625		2797	2822	2988	3002	3142	3324	3447	3583	3735	4297	4484	4651	4817	4951	5070	5184	5299	-	-	-	-	
2675		-	-	-	3148	3330	3454	3597	3743	4306	4495	4661	4829	-	-	-	-	-	-	-	-	-	
2750		-	-	-	3196	3472	3581	3708	3819	4434	4600	4796	4910	-	-	-	-	-	-	-	-	-	
2875		-	-	-	3206	3483	3593	3721	3832	4450	4617	4814	4929	-	-	-	-	-	-	-	-	-	
3000		-	-	-	3214	3492	3602	3732	3844	4463	4631	4671	4944	-	-	-	-	-	-	-	-	-	
3100		-	-	-	3214	3492	3602	3732	3844	4463	4631	4671	4944	-	-	-	-	-	-	-	-	-	

Deco paint only available in Golden Oak, Anthracite Metallic (Noir 2100 Sable) or Rosewood finish.

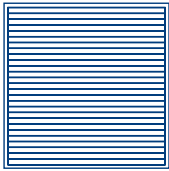

Timber effect finish

Door height	Door width																						
	1000	1250	1500	1750	1900	2000	2250	2500	2750	3000	3250	3500	3750	4000	4250	4500	4750	5000	5250	5500	5750	6000	
1600																							
1875	2665	2698	2823	2842	2881	3051	3176	3303	3376	3645	3773	4198	4317	4515	4635	4761	4887	5317	5444	5570	5695		
2000	2676	2711	2838	2859	2897	3071	3199	3328	3402	3673	3804	4231	4231	4552	4674	4802	4931	5363	5491	5620	5747		
2125	2687	2724	2853	2875	3007	3210	3293	3408	3527	3810	3952	4415	4415	4754	4882	5013	5141	5575	5703	5834	5964		
2250	2698	2737	2869	2892	3069	3316	3422	3525	3679	4002	4389	4573	4573	4904	5031	5163	5292	5730	5858	5985	6112		
2375	2709	2750	2884	2909	3087	3336	3444	3549	3704	4030	4420	4606	4606	4941	5070	5205	5335	5775	5906	5985	6165		
2500	2887	2931	3115	3141	3196	3402	3543	3699	3831	4171	4591	4709	4709	5118	5256	5391	5522	5963	6093	6035	6360		
2625	2899	2944	3130	3157	3306	3507	3650	3812	3980	4562	4769	4957	4957	5297	5438	5572	5706	-	-	-	-		
2675	2903	2949	3136	3164	3312	3514	3659	3823	3990	4573	4782	4970	4970	5312	5453	5589	5724	-	-	-	-		
2750	-	-	-	3323	3526	3672	3837	4006	4590	4800	4990	4990	-	-	-	-	-	-	-	-	-		
2875	-	-	-	3380	3678	3809	3960	4092	4732	4920	5139	5139	-	-	-	-	-	-	-	-	-		
3000	-	-	-	3397	3698	3831	3984	4119	4761	4951	5172	5172	-	-	-	-	-	-	-	-	-		
3100	-	-	-	3411	3713	3391	4003	4140	4783	4975	5198	5198	-	-	-	-	-	-	-	-	-		

Timber Effect Foil Coat only available in Golden Oak and Rosewood finish.

Options for GaraRoll doors

	add
Surcharge for different colour frame and guides to door colour	159
Manually operated version (not possible on external fit)	Price reduction 253
Removal of barrel casing (optional only on door height 2500 mm and over)	Price reduction per m 26
External fit (reverse rolled)	115
Chamfered bottom profile available only in White or Colour. Not available in timber effect finish	per m 332
Ventilation grilles or Glazing element with clear synthetic pane, window section 120 x 40 mm, black glazing frame on exterior, transparent on interior (maximum of 10 sections per door, number of glazing elements dependent on the door width) ¹	per m 42

¹ Not available in top 6 laths.

Accessories for GaraRoll operator

	add
Bi-directional hand transmitter, 5-channel in black	93
Bi-directional hand transmitter mini, 4-channel in black	79
Motor connection line, 10 m - Reference No. 5498	60
Acoustic door security kit - Reference No. 8671	99
Emergency battery HNA 18 - Reference No. 5500	282
Exterior emergency release - Reference No. 5501	152
Additional fascia panel required when fitting a door within the opening, ordering size will need to be door size plus guide width (price per metre) supplied in colour to match the door / guides	77

All other operator accessories can be combined with GaraRoll roller doors. Please see page 73 to page 76.

GaraRoll is also available with a colour door curtain and white guide rails and box cover, at an additional cost of £166.
If required, please state clearly on your order.

Roller door fitting dimensions

Fitting behind the opening

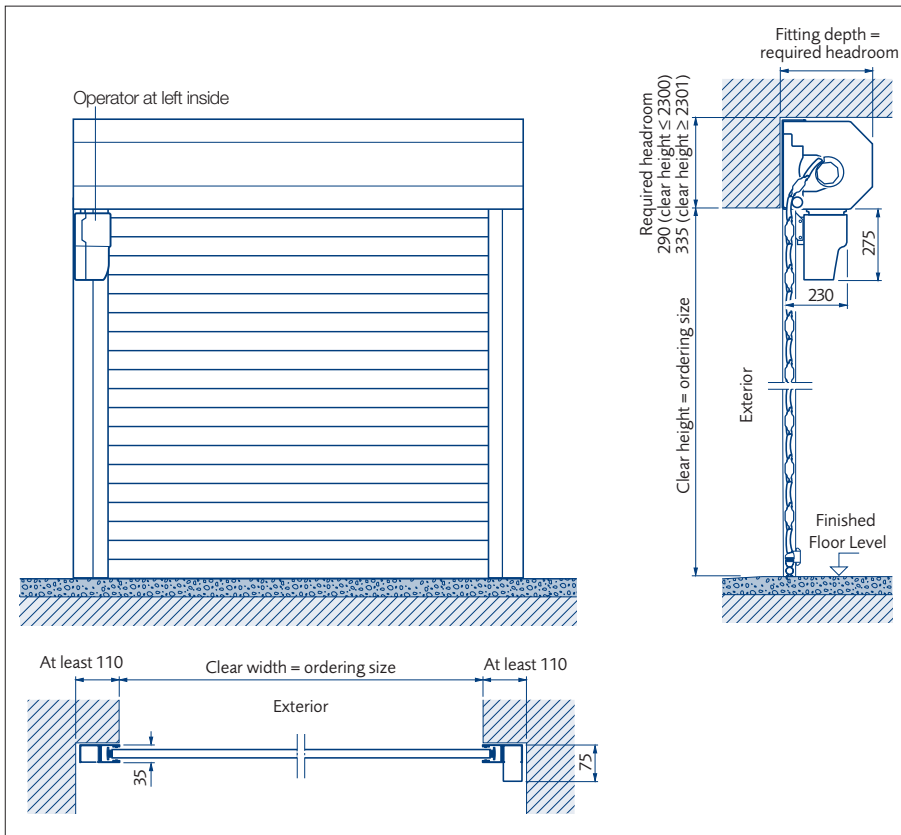

Clear passage width =
clear width (ordering size)

Clear passage height =
clear height (ordering size)
– 80 mm for automated version,
– 140 mm for manually operated version

Fitting in the opening

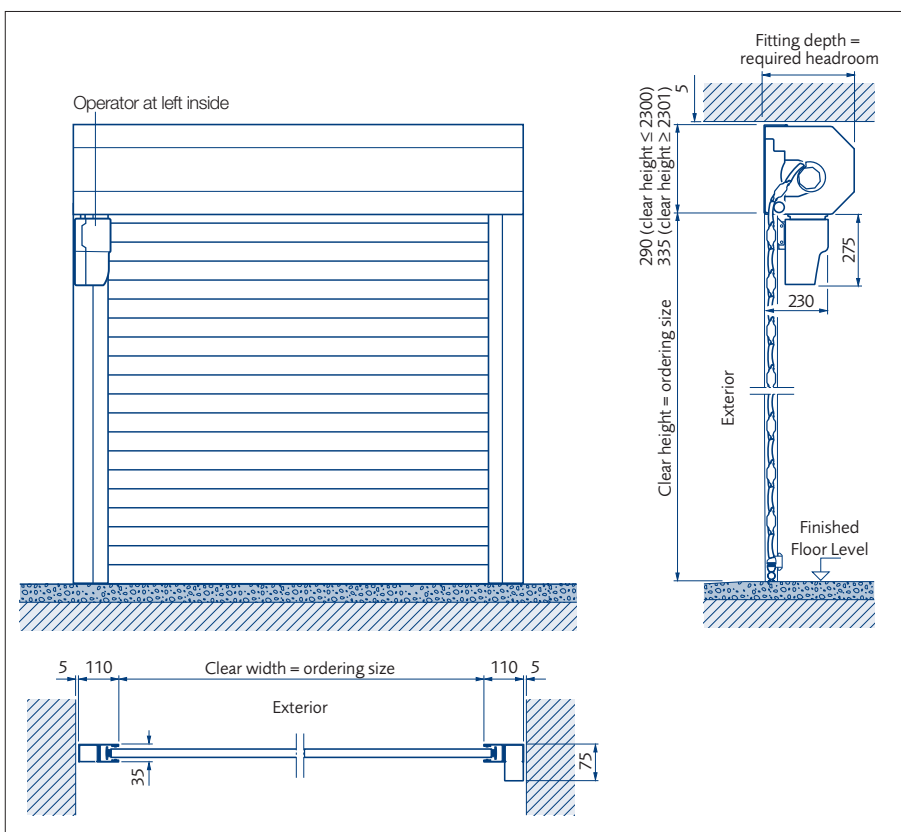

Clear passage width =
clear width (ordering size)

Clear passage height =
clear height (ordering size)
– 80 mm for automated version,
– 140 mm for manually operated version

GaraGlide Roller Doors

A motor driven, roller garage door with tubular drive motor, closing edge safety device and manual hand crank for emergencies. The emergency release kit is not available for a retro-fit application so must be ordered with the original door. All doors are built to suit the opening, with the actual door size relating to the structural opening width x height and the guides fitting on the reveals to maintain a full opening size. Please refer to sizing tables for full range of size options.

Door Curtain

77 mm rolled aluminium profile with 100 % CFC-free polyurethane rigid foam. Available in 16 standard colour, with a two-layer paint finish using a high-quality polyurethane paint coated with a polyimide. Each lath is 15 mm thick.

Frame and Construction

75 mm guide rails for single doors and 105 mm for double doors. Guide rails are supplied in a colour to match the door curtain and with an integrated brush strip either side. The box cover, rollers and barrel are pre-assembled for convenience. Please state on your order if fitting between or behind opening.

Operator and Control

GaraGlide operator and control included. 24 V DC gear drive, mains voltage 230 - 240 V AC, 0.5 KW, anti-lift kit, operator built into tubular drive with control board located on right as standard (viewed from inside) and impulse control. Operator with mechanically adjustable end-of-travel position. Included: 2 x bisecur 868 MHz hand transmitters and integral receiver, connecting lead with CEE plug, control buttons in cover of the control unit, integrated 2-minute garage courtesy light in control housing. The motor can be fitted either side. Also features an adjustable reversing procedure, adjustable pre-warning phase, adjustable automatic timer, connection of external illumination is possible and there is also a connecting option for a one-way photo cell.

Standard Colours

GaraGlide roller doors are available in a choice of 15 standard colours, with the door curtain interior and exterior painted the same colour:

- Traffic White (RAL 9016)
- Steel Blue (RAL 5011)
- Light Grey (RAL 7035)
- White Aluminium (RAL 9006)
- Light Ivory (RAL 1015)
- Moss Green (RAL 6005)
- Terra Brown (RAL 8028)
- Grey Aluminium (RAL 9007)
- Ruby Red (RAL 3003)
- Slate Grey (RAL 7015)
- Cream (RAL 9001)
- Chartwell Green
- Purple Red (RAL 3004)
- Anthracite Grey (RAL 7016)
- Jet Black (RAL 9005)

Anthracite Metallic (Noir 2100 Sable) is also available at an additional cost. See page 83 for additional colour options.

Timber Effect Colours

A timber effect version is available in Golden Oak or Rosewood effect, where the exterior door curtain is coated in a UV-resistant synthetic foil with a timber effect design and embossed grain, and the interior of the door curtain is painted in Terra Brown (RAL 8028). A Deco Paint version is also available at a lower cost, where the laths are painted in a Golden Oak or Rosewood effect.

Fitting

The GaraGlide is suitable for fitting between and behind a prepared brickwork opening.

Packaging

GaraGlide roller doors are supplied in two twin-walled cardboard boxes for ease of transportation to site.

Stock Availability

All GaraGlide doors are made to order with no standard sizes. Lead-time for all doors is 4 weeks.

Size range

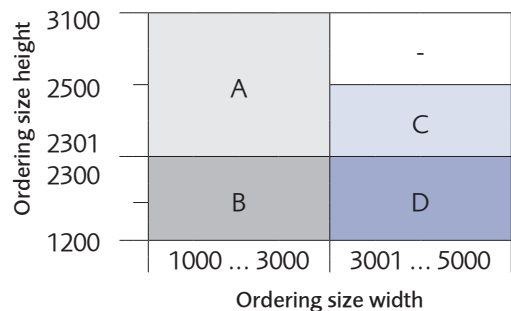

- A** Box 335, 75 mm guide rail, 70 mm shaft, no wind locks.
- B** Box 290, 75 mm guide rail, 70 mm shaft, no wind locks.
- C** Box 335, 105 mm guide rail, 80 mm shaft, with wind locks.
- D** Box 290, 105 mm guide rail, 80 mm shaft, with wind locks.

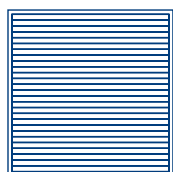

Smooth paint finish

Door height	Door width																		
	1000	1250	1500	1750	1900	2000	2250	2500	2750	3000	3250	3500	3750	4000	4250	4500	4750	5000	
1200																			
1500	2122	2175	2199	2250	2250	2299	2349	2395	2466	2834	2882	2934	2978	3026	3090	3136	3189		
1750	2158	2211	2248	2303	2303	2358	2415	2470	2543	2919	2975	3026	3080	3136	3204	3258	3314		
2000	2185	2244	2288	2349	2349	2406	2461	2521	2602	2987	3044	3104	3163	3221	3295	3351	3411		
2125	2196	2253	2299	2358	2358	2417	2480	2539	2618	3007	3067	3125	3189	3248	3323	3380	3444		
2250	2211	2277	2321	2384	2384	2447	2514	2576	2656	3052	3115	3177	3241	3302	3380	3444	3504		
2375	2241	2307	2358	2424	2424	2495	2563	2631	2717	3115	3180	3248	3314	3480	3561	3628	3697		
2500	2250	2318	2372	2440	2440	2505	2579	2647	2737	3136	3207	3274	3346	3457	3595	3664	3730		
2625	2288	2363	2420	2495	2495	2571	2647	2720	2816	3225	3299	3373	3447	-	-	-	-		
2675	2288	2363	2420	2495	2495	2571	2647	2720	2816	3225	3299	3373	3447	-	-	-	-		
2750	2288	2363	2420	2495	2495	2571	2647	2720	2816	3225	3299	3373	3447	-	-	-	-		
2875	2321	2406	2470	2546	2546	2631	2708	2791	2894	3411	3487	3569	3650	-	-	-	-		
3000	2321	2406	2470	2546	2546	2631	2708	2791	2894	3411	3487	3569	3650	-	-	-	-		
3100	2321	2406	2470	2546	2546	2631	2708	2791	2894	3411	3487	3569	3650	-	-	-	-		

Additional Colour Options

Standard colours (choice of 15 colour options)	Included	
Anthracite Metallic (Noir 2100 Sable)	per m ²	39
Deco Paint (painted timber effect design in Golden Oak or Rosewood)	per m ²	39
Timber effect (plastic film coating in Golden Oak or Rosewood timber effect)	per m ²	70

Add £69 surcharge for external fit GaraGlide roller door.

Add £173 surcharge, to request the door curtain in one colour and the guide rails/box cover in an alternative colour.

Example of paint cost calculation:

For door dimensions of 2000 mm x 2125 mm, the door area is 4.25 m² (i.e. 2 x 2.125 = 4.25).

Multiply door area by cost per m² to calculate additional paint cost (i.e. 4.25 x 39 = £165.75).

Please note, dark colours should not be used for doors that are exposed to the sun. Despite the use of state-of-the-art colour coating systems, we cannot rule out colour deviations, specifically in metallic colours (RAL 9006 and RAL 9007).

Please state on your order if fitting between or behind opening.

External fit GaraGlide roller doors are only available up to 5000 mm wide and are not available in a timber effect finish.

GaraGlide is also available with a colour door curtain and white guide rails and box cover, at no extra charge. If required, please state clearly on your order.

Roller door fitting dimensions

Fitting behind opening

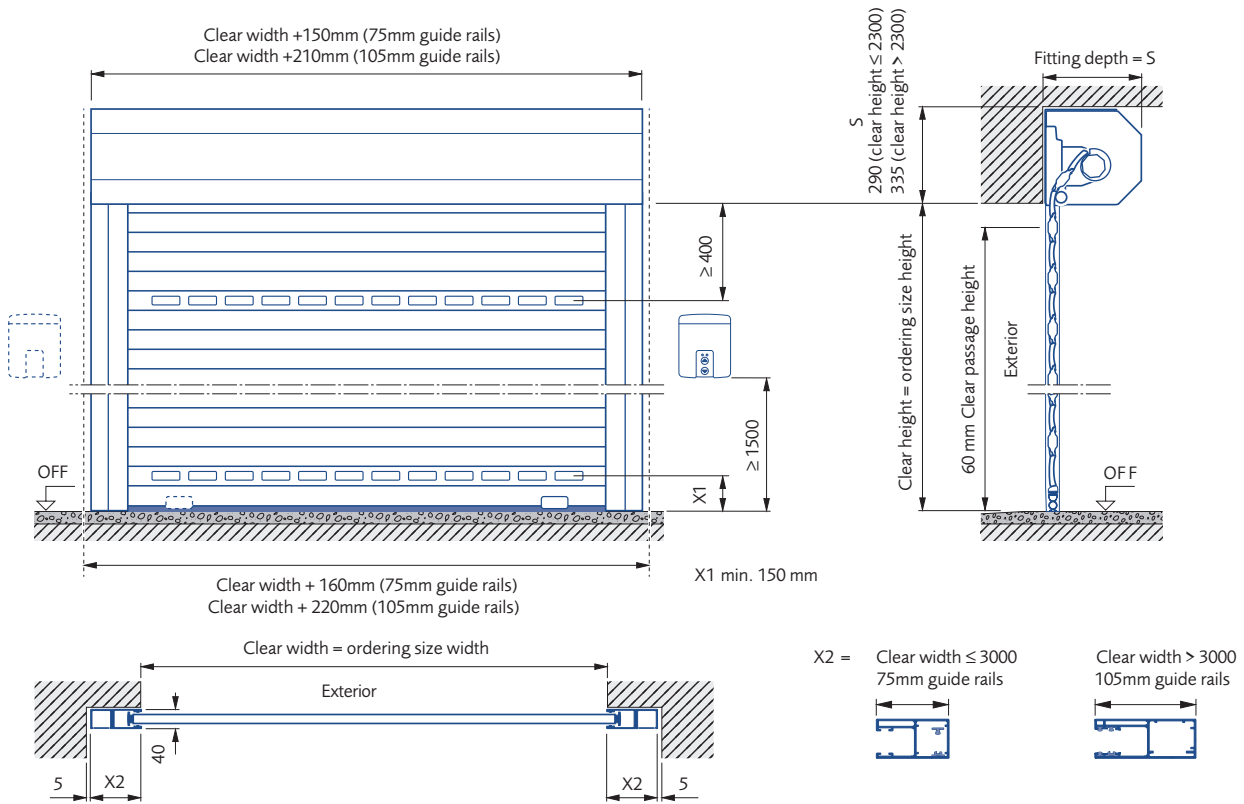

Fitting between opening

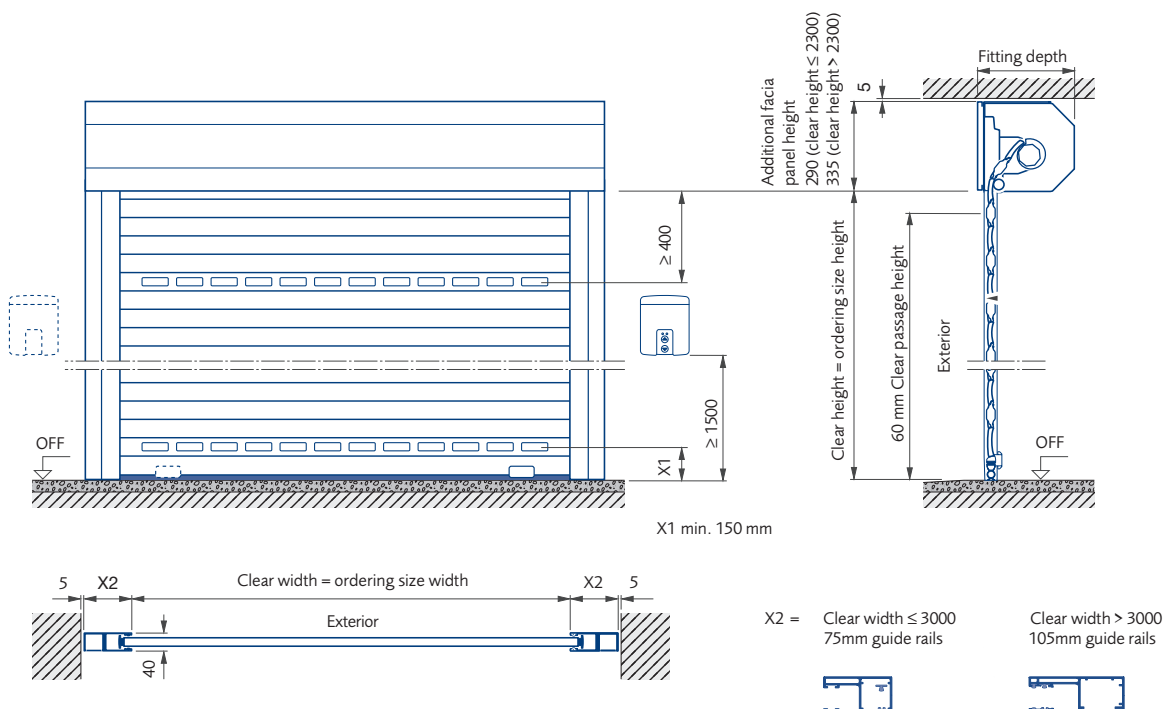

Options for all GaraGlide roller garage doors

Emergency Release

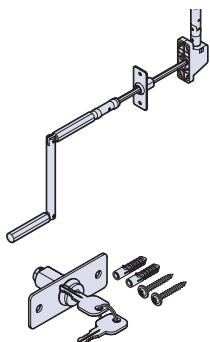

Exterior emergency release kit
(Please note: the emergency release kit is not available for a retro-fit application so must be ordered with the original door).

each

277

Ventilation Grilles and Glazing Elements



Glazing element (clear synthetic pane, window cut-out 112 mm x 33 mm)

per m

39



Ventilation grilles (black plastic with ventilation cross section approx 13 cm² / grille)

per m

39

Additional Fascia Panel

Reinforcement of the fascia panel (required for fitting between opening)

per m

99

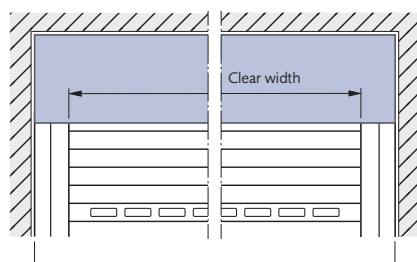
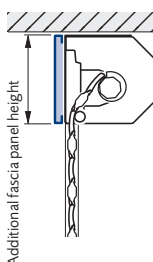
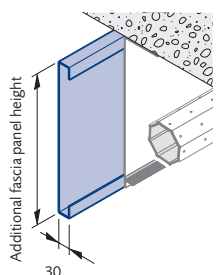

Additional fascia panel width = clear width +150 (75mm guide rails)
Additional fascia panel width = clear width +210 (105mm guide rails)

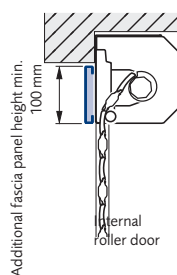

Internal roller door

External roller door

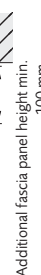

External fit (reverse rolled)

69

Operator with electronically adjustable end-of-travel positions

432

Wireless optical sensor

236

User Information / Care

A Garador garage door needs only a minimum level of preparation and maintenance to give years of trouble-free service. Below is a guide to how to get the best from your garage door.

Operation

- For opening the door in manual operation use only the outside handle or inside handle. Never use the pull rope during the opening cycle of the door.
- For closing the door from the outside – the pull rope fixed to the internal handle is only designed to pull the door towards you whilst standing within the entrance of the garage until the door can be pushed down by hand, then using the external handle for final closing.
- For closing the door from the inside – the pull rope already mentioned is designed to be pulled away from you, when facing the front entrance of the garage, until the internal handle is able to be reached, by hand, and used for final closing. The pull rope is not designed to be used for any other part of the operating cycle, or any other purpose. Failure to comply with the above instructions may result in injury to persons or property.
- When the door is operated from either outside or inside, check the area through which the door will travel is clear from people and objects. Failure to do so may result in injury to persons or property.
- When closing, ensure the latches engage properly.
- If the door is power-operated always try to ensure you match the door with a GaraMatic electric operator.

Power Operated Garage Doors

- It is against the Law to install a power operated garage door in the UK without complying with The Machinery Directive.
- To comply with the Machinery Directive both the door and the operator used in the Installation must have a declaration of Incorporation from the manufacturer.
On completion of the installation the Installer must provide a Declaration of conformity and apply a CE mark giving details of the installation to the door/operator combination, which is now classed as a machine.
- The Installer must issue to the Customer a declaration of conformity on the completion of the installation.
- The Installer must hold copies of both the Declarations of Incorporation and the Declaration of Conformity on a technical file for inspection by the relevant authorities.
- If any of the above requirements are not fulfilled the Installation is illegal.
- Please ensure for your own safety and peace of mind that whoever installs your electric operator is both willing and able to fulfil these requirements; if they are not do not use them !!
- Members of the DHF CAN and WILL install your operator safely and legally.

Cleaning

- The door and frame if applicable, should be washed with a mild soap-based solution on a regular basis to prevent the build up of dirt, salts and other corrosive substances and help maintain the aesthetic appearance of the product.
- If the door is installed in a coastal location, the door panel and frame should be cleaned in this way at least every two months.
- We also suggest that all other components be brushed down on a regular basis to prevent the build up of dirt and dust etc.
- On GaraRoll roller doors regular removal of dirt and debris is required to avoid damage to laths when the curtain rolls.

Locking

- If the key is turned completely, the door is then locked or unlocked; when unlocked it is then possible to open and close the door by turning the handle.
- If the key is turned 1/4 of the way, the door opened and then the key returned to its start position, the door will re-lock when closed.
- By moving the internal locking "snib", it is possible to lock and unlock the door from the inside without using the key, except on SBD doors where there is no internal snib/locking system.

Maintenance

- If in doubt about any of these maintenance procedures below always consult a Garador specialist. Garador Ltd. has a nationwide network of installers who will be able to offer you a regular maintenance service on your garage door. Please call Garador or refer to the Garador website for further details of your nearest installer.
- Immediately after the door is fitted and after every 5,000 operations of the door, or at least once a year, oil all pivot points, check screws and clamped connections for tightness, keep the running tracks clean (do not grease them), check parts and replace any worn components where necessary.
- The springs should be replaced after approx. 25,000 operations by an experienced door fitter (see fitting and operation instructions).
- Do not oil the lock cylinder; if it is sticking, only lubricate with graphite dust.
- For canopy doors only, check the cable every 6 months with normal usage (8 operations per day). Have the cables replaced by an expert if any wear is found.

Finish – Steel Doors

The coating process applied to the door and chassis is environmentally friendly. Minor scratches or marks are not covered under the conditions of our warranty and should be repaired immediately to prevent corrosion and deterioration of the panel. Corrosive substances such as acids, alkalines, and salts, etc. should be cleaned from the door immediately; failure to do so will result in deterioration of the finish, which will not be covered under our warranty. Garador steel doors are finished products. They do not require immediate painting on-site. They are however not immune to damage, which can occur at any stage of the handling of the product from factory to site. Should deterioration of the finish start to occur you will need to repaint your door immediately. Prepare the surface lightly with wet and dry. Then treat with solvent based 2 pack epoxy wash primer and a normal commercial paint (cellulose paint must not be used).

Minor surface damage can easily be repaired using touch up sprays or paint sticks without invalidating your warranty.

Finish – Timber Doors

Timber panels are coated with a neutralising base-stain. Doors must be stored upright, under cover in a dry location, with wrapping intact, until wrapping is removed. As soon as the door is unwrapped, one coat of a good quality basecoat primer must be applied to both sides of the door. Immediately after installation, your timber doors require a further two coats of a good quality exterior wood finish on both sides.

Initial application and periodic treatment should be carried out strictly in accordance with the woodstain manufacturer's instructions.

Failure to follow these instructions will result in early deterioration of the timber panel which would not be covered under our warranty.

Finish – GRP Doors

GRP door panels should be periodically washed down using water. This should be done more frequently if fitted in a coastal location.

Bird droppings will bleach the finish on GRP and should be removed using water as soon as possible.

GRP doors should not be painted over.

Warranty

Garador products are manufactured to the highest quality standards and leave our factory only after rigorous quality testing. However, if you should have grounds for complaint, this section tells you what our door warranty offers, and how to go about making your claim.

In the unlikely event of a warranty claim becoming necessary, please contact the dealer or distributor who originally supplied your garage door. Your dealer should then supply details of the claim, together with a copy of the warranty card provided with the door and proof of purchase to the Warranty Department at Garador Ltd.

To enable your claim under warranty to be processed as quickly as possible, you should provide the following details:

- 1 Your name, address and telephone number
- 2 Original invoice with date of purchase
- 3 Product description/door type and product number
- 4 Description of defect

An assessment of the claim will then be made. This may require Garador to inspect the product in-situ. In the event that there is no legitimate warranty claim under the terms specified herein, you may be liable for the costs of the inspection visit. We strongly recommend that you take note of the care and usage instructions displayed on the stickers on the back of your garage door and on the previous page and that you follow these instructions throughout.

Garador installers

Garador Ltd. has a nationwide network of recommended installers who will be able to offer you a regular maintenance service on your garage door. Please call us on 01935 443722 or refer to the Garador website for further details of your nearest installer.

Garador Garage Door Warranty

Warranty Period

The purchaser is granted a warranty covering the safe and reliable function of the Garador garage door for a period of 10 years from the date of purchase. A 5 year warranty applies to springs, wire cables, track rollers, hinges and guide rollers. The warranty period for replacement parts is 6 months or to the end of the current warranty period, whichever is longer.

In the case of foil-coated timber effect and PVC doors, a warranty of 5 years is granted, for timber and GRP doors a warranty of 2 years is granted on the door panels alone under the terms and conditions specified herein. The door mechanism and steel frame (if applicable) is covered by the 10 year warranty period.

Requirements

Warranty claims are only applicable in the country where the garage door was purchased. The product must have been purchased through our authorised distribution channels. The warranty only covers damage to the contract object. The fully completed warranty card together with the receipt of purchase correspondingly dated substantiates your right to claim under the warranty.

Performance

During the warranty period we undertake to rectify any and all defects to the Garador product which can be proved to be attributed to a material or manufacturing fault.

We pledge at our discretion either to exchange the defective merchandise for faultless merchandise, repair it or allow a reduction in price. We do not accept costs for dismantling and installation nor for carriage.

Replaced parts become our property.

The warranty does not cover damage caused through:

- normal wear and tear
- improper installation
- negligent care and maintenance
- improper initial and subsequent operation
- negligent or wanton destruction
- external influences such as fire, water, salts, alkaline solutions, acids, abnormal environmental influences
- mechanical damage through improper transport and fitting
- priming and other surface protection treatments
- incorrect or too late applied surface protection treatments
- repair by non-qualified persons
- using non-Garador parts without the approval of the manufacturer
- Removal of the product number or making it unidentifiable

Warranty GaraRoll and GaraGlide

GaraRoll and GaraGlide roller doors are subject to a limited 10 year warranty. The design of these doors represents state of the art technology. Pressure marks and abrasive wear, particularly on the top profiles are a condition of the design and cannot be avoided. They are not considered a reason for complaint.

In order to avoid excessive friction, remove any dirt and debris from the door curtain at regular intervals. For motors and controls, see warranty below.

In addition to the statutory warranty provided by the dealer in the sales contract, we grant the following warranty for parts from the date of purchase:

- 5 years on operator technology, motor and motor control.
- 2 years on radio equipment, accessories and special systems.

Claims made under the warranty do not extend the warranty period. For replacement parts and repairs the warranty period is six months or at least the remainder of the warranty period.

General wear and tear:

Due to the design of the roller door, the inside of the door curtain will exhibit some marks after a short period of time. This is classed as general wear and tear that you would expect to see over a period of months or years. It is not detrimental to the door's performance and would therefore not be grounds for a warranty claim.

Pre-requisites:

The warranty claim only applies in the country where the equipment was purchased. The product must have been purchased through our authorised distribution channels. A claim under this warranty exists only for damage to the object of the contract itself. The receipt of purchase substantiates your right to claim under the warranty.

Services:

For the duration of the warranty we shall eliminate any product defects that are proven to be attributable to a material or manufacturing fault. We pledge to replace free of charge and at our discretion the defective goods with non-defective goods, to carry out repairs, or to grant a price reduction. Replaced parts become our property. Reimbursement of expenditure for dismantling and fitting, testing of parts as well as demands for lost profits and compensation for damages are excluded from the warranty.

Damage caused by the following is also excluded:

- improper fitting and connection
- improper initial start-up and operation
- external factors such as fire, water, abnormal environmental conditions
- mechanical damage caused by accidents, falls, impacts
- negligent or intentional destruction
- normal wear or deficient maintenance
- repairs conducted by unqualified persons
- use of non-original parts
- removal or defacing of the data label

Electric Operator Warranty

A separate 5 year warranty is granted on our electric operators. This includes operator mechanics, motor and motor control systems. A 2 year warranty is granted on radio equipment, accessories and system controls. There is no warranty on consumables (e. g. fuses, batteries, bulbs etc.).

For further details please contact us on 01935 443722, or through our website on www.garador.co.uk

Extracts from DHF consumer advice

The following document has been created by the Door and Hardware Federation (DHF) and endorsed by all major UK garage door manufacturers, as a guide for purchasers and domestic garage doors.

Visual Appearance of Garage Doors

A new garage door can be a significant investment that will transform the appearance of your home. This information is a guide to the quality you can expect.

The Quality Check

The quality check should be carried out in natural daylight, not direct sunlight. Stand at a distance of 3 metres from the door to view the overall appearance. The door is acceptable if, taking into account the facts below, none of the following are readily visible on the face of the door:

- Marks or distortion associated with the manufacturing process
- Minor indentations, marks or scuffs on the surface
- Paint or stain blemishes

The Facts

Steel Doors

- Panel Distortion

The rolling or pressing of steel panels during manufacture will cause distortion in the steel and while every effort is made to keep this to a minimum, inevitably some visible distortion will remain. The application of high gloss paints will make this slight distortion more apparent, especially under certain lighting conditions, such as car headlamps, or bright sunshine.

- Paint Finish

Primed doors – the primer coating is applied as a base coat only and as such requires additional finishing with a good quality exterior paint.

Any marks or scratches on the primer coat should be rubbed down and repainted as part of this finishing process.

Finished doors – the factory application of the paint finish is an automated process and this may result in minor blemishes or slight inconsistencies in the paint, particularly in the area of panel joints.

Timber Doors

- Timber

Timber is a natural product and there will be variations in pattern, colour, shading and grains. No two doors will be the same. Wood naturally expands and contracts according to environmental conditions, joints will open and close and some minor curvature may occur.

- Finishing

It is vital that timber doors are fully finished as per the manufacturers instructions before exposure to the elements.

GRP and composite Plastic Doors

- Mould Marks

GRP doors are individually handcrafted in a mould and are then hand finished. Some minor marks and blemishes will inevitably remain after this process.

- Translucency

When viewed from the inside, it is often possible to see variations in the translucency of the door, particularly around and between areas of relief. Such variations do not detract from the overall strength or build quality of the door.

All Doors

- Colour Match

Pairs of doors should be ordered together to obtain the best colour match, bearing in mind the limitations of the materials used in the construction. Timber garage doors cannot be ordered as matching sets.

- Size Variations

As the size of a door changes in height and/or width, the panel frequency and profile can change, therefore doors of the same style but of different sizes can be significantly different in appearance.

- Clearances

All doors require operating clearances, i.e. the gap between the door panel and the frame opening, these are inbuilt during manufacture and should not be reduced by means of infills, or draughtproofing.

- Deflection

When in the open position, all doors will display a level of vertical deflection or 'sag' across the width of the panel. Individual manufacturers' specifications should be consulted for exact tolerances.

GARADOR

The Garage Door People

Bunford Lane, Yeovil, Somerset, BA20 2GL
Tel: (01935) 443722 Fax: (01935) 443744

www.garador.co.uk



Garador is the UK's leading manufacturer of garage doors and operators, with an ultra-modern production facility located in Somerset. We use German engineering expertise to produce highly sophisticated doors and operators. By purchasing a Garador product you can be assured of the highest level of quality, safety and security. With a nationwide network of stockists, installers and service technicians we are an ideal partner for your project.